

1. General Description of Aluminum Electrolytic Capacitors

1-1 Principles of Aluminum Electrolytic Capacitors

An aluminum electrolytic capacitor consists of cathode aluminum foil, capacitor paper (electrolytic paper), electrolyte, and an aluminum oxide film, which acts as the dielectric, formed on the anode foil surface.

A very thin oxide film formed by electrolytic oxidation (formation) offers superior dielectric constant and has rectifying properties. When in contact with an electrolyte, the oxide film possesses an excellent forward direction insulation property. Together with magnified effective surface area attained by etching the foil, a high capacitance yet small sized capacitor is available.

As previously mentioned, an aluminum electrolytic capacitor is constructed by using two strips of aluminum foil (anode and cathode) with paper interleaved. This foil and paper are then wound into an element and impregnated with electrolyte. The construction of an aluminum electrolytic capacitor is illustrated in Fig. 1-1.

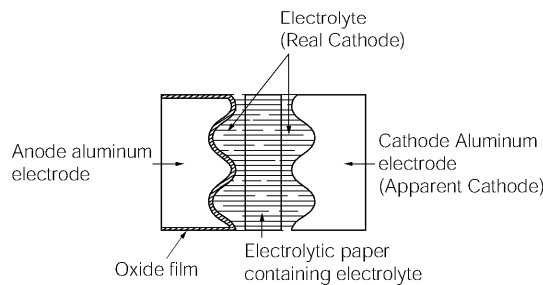

Fig. 1-1

Since the oxide film has rectifying properties, a capacitor has polarity. If both the anode and cathode foils have an oxide film, the capacitors would be bipolar (non-pola) type capacitor.

These technical notes refer to "non-solid" aluminum electrolytic construction in which the electrolytic paper is impregnated with liquid electrolyte. There is another type of aluminum electrolytic capacitor, which is the "solid" that uses solid electrolyte.

1-2 Capacitance of Aluminum Electrolytic Capacitors

The capacitance of an aluminum electrolytic capacitor may be calculated from the following formula same as for a parallel-plate capacitor.

$$C = 8.855 \times 10^{-8} \frac{\epsilon S}{d} (\mu F) \dots\dots\dots (1-1)$$

- ε : Dielectric constant of dielectric
- S : Surface area (cm²) of dielectric
- d : Thickness (cm) of dielectric

To attain higher capacitance "C", the dielectric constant "ε" and the surface area "S" must increase while the thickness "d" must decrease. Table 1-1 shows the dielectric constants and minimum thickness of dielectrics used in various types of capacitors.

With aluminum electrolytic capacitors, since aluminum oxide has excellent withstand voltage, per thickness. And the thickness of dielectric can be freely controlled according to the rated voltage of the aluminum electrolytic capacitor.

Therefore, in compare to other dielectric, similar voltage endurance is provided by dielectric even if thickness ("d" in the above formula) is thin.

Furthermore, by etching the surface of aluminum foil, the effective area of the foil as compared to the apparent area can be enlarged 80~100 times for low voltage capacitors and 30~40 times for middle / high voltage capacitors. Therefore, aluminum electrolytic capacitors have a higher capacitance for a specified apparent area than other types of capacitors.

High purity aluminum foil for the anode is etched by electrochemical process in a chloride solution with DC, AC, or an alteration of DC and AC, or a concurring AC and DC current. Fine surface etching (photo 1-1) accomplished mainly by AC electrolysis is generally used for foil with a low voltage rating. Tunnel etching (photo 1-2) accomplished mainly by DC electrolysis is used for middle / high voltage foil. The etching of the cathode foil is mainly accomplished by AC electrolysis to increase the surface area.

Table 1-1 Dielectric constants and minimum thickness of dielectrics used in various types of capacitors

Type of Capacitor	Dielectric	Dielectric Constant ε	Dielectric Thickness d (μm)
Aluminum Electrolytic Capacitor	Aluminum Oxide	7~10	(0.0013~0.0015/V)
Tantalum Electrolytic Capacitor	Tantalum Oxide	24	(0.001~0.0015/V)
Film Capacitor (Metallized)	Polyester Film	3.2	0.5~2
Ceramic Capacitor (High Dielectric Constant Type)	Barium Titanate	500~20,000	2~3
Ceramic Capacitor (Temp. Compensation Type)	Titanium Oxide	15~250	2~3

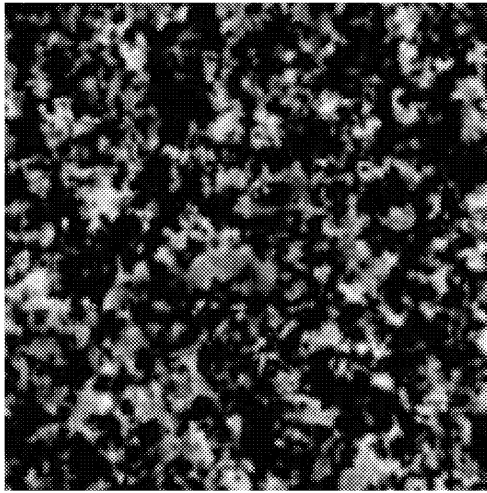

Surface

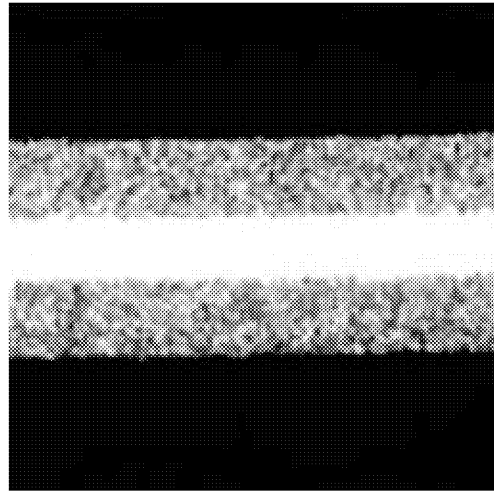

Section

Photo 1-1 Surface and section photo of etched aluminum foil for low voltage capacitors.

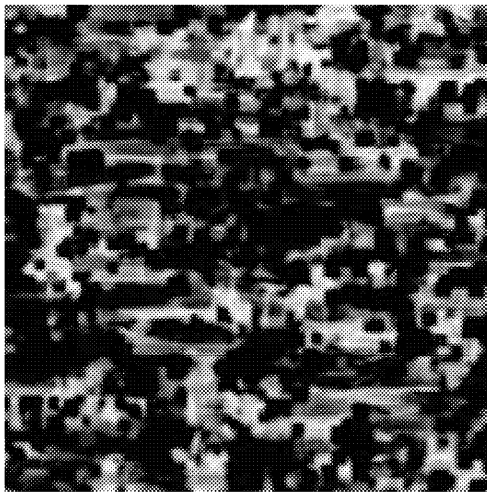

Surface

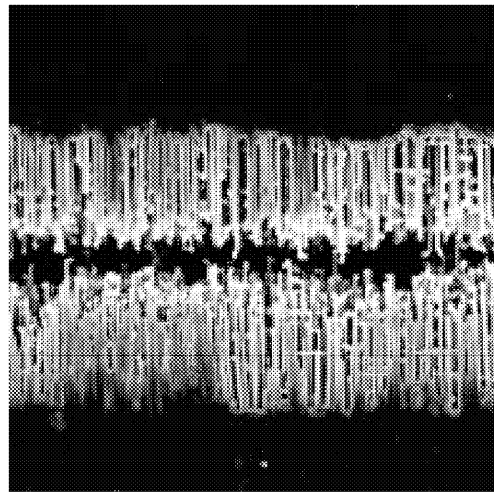

Section (Replica)

Photo 1-2 Surface and section photo of etched aluminum foil for middle / high voltage capacitors.

1-3 Dielectric (Aluminum Oxide Layer)

A high purity etched aluminum foil is anodized in a boric acid-ammonium water type solution, for example, to form an aluminum oxide film on its surface. This aluminum oxide film is what we call the dielectric of the aluminum electrolytic capacitor. The DC voltage that is applied to the foil to oxidize the anode foil is called "Forming Voltage".

The thickness of the dielectric is nearly proportional to the forming voltage and measures approximately

0.0013~0.0015 (μm)/ V.

Expanded photography of a dielectric (aluminum oxide layer) on the foil that has not been etched (plain foil) is shown in photo 1-3.

The fabrication reaction of the dielectric can be expressed as follows:

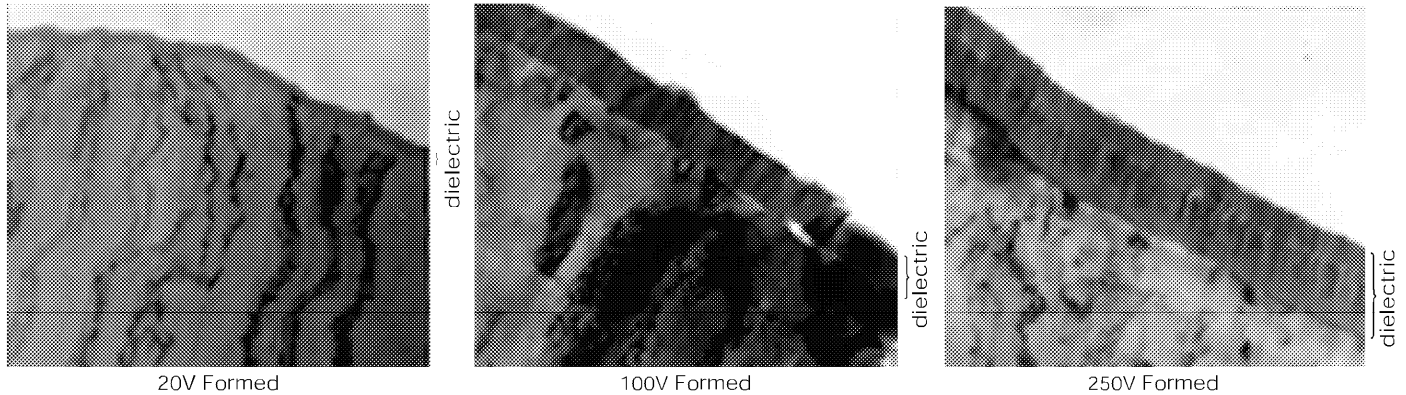
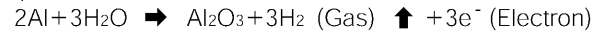

Photo 1-3 Enlarged photo of oxide layer formed on a non-etched plain aluminum foil.



Photo 1-4 Enlarged photo of middle, high voltage formed foil. (Condition of oxide layer formation in a pit)

1-4 Electrolyte

Anode foil and a cathode foil facing each other are interleaved with electrolytic paper and wound into a cylindrical shape. This is called a "capacitor element." At this stage, it has configuration of a capacitor when considers electrolytic paper and the aluminum oxide layer to be dielectric, however, the unit has few capacitance.

When this capacitor element is impregnated with liquid electrolyte, the anode foil and cathode foil are electrically connected. With the aluminum oxide layer formed on the anode foil acting as the sole dielectric, a capacitor with a high value of capacitance is now attainable. That is to say that the electrolyte is now functioning as a cathode. The basic characteristics required of an electrolyte are listed below:

- (1) It must be electrically conductive.
- (2) It must have a forming property to heal any flaws on the dielectric oxide of the anode foil.
- (3) It must be chemically stable with the anode and cathode foils, sealing materials, etc.
- (4) It must have superior impregnation characteristics.
- (5) Its vapor pressure must be low.

The above characteristics of electrolyte greatly influence the various characteristics of aluminum electrolytic capacitors. For this reason, the proper electrolyte is determined by the electrical ratings, operating temperatures and the application of the capacitor.

1-5 Manufacturing Process of Aluminum Electrolytic Capacitors

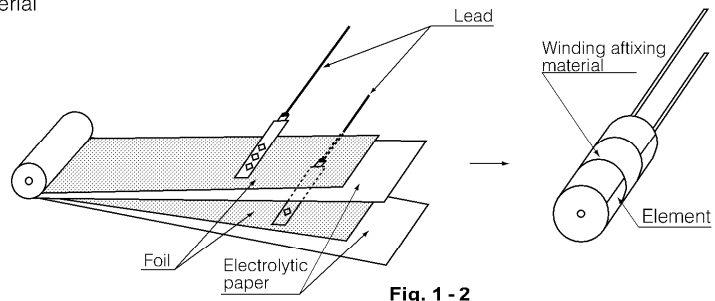
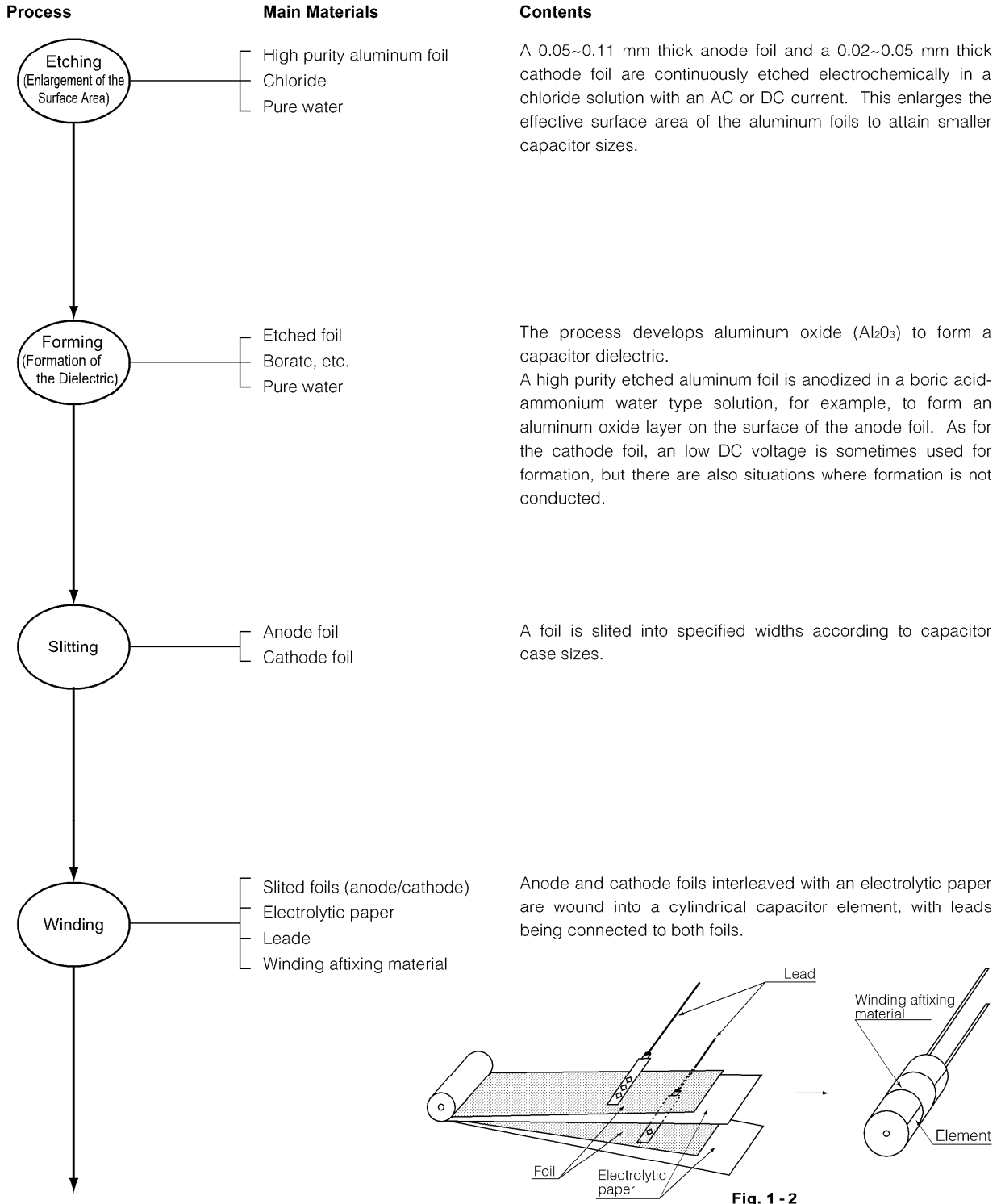
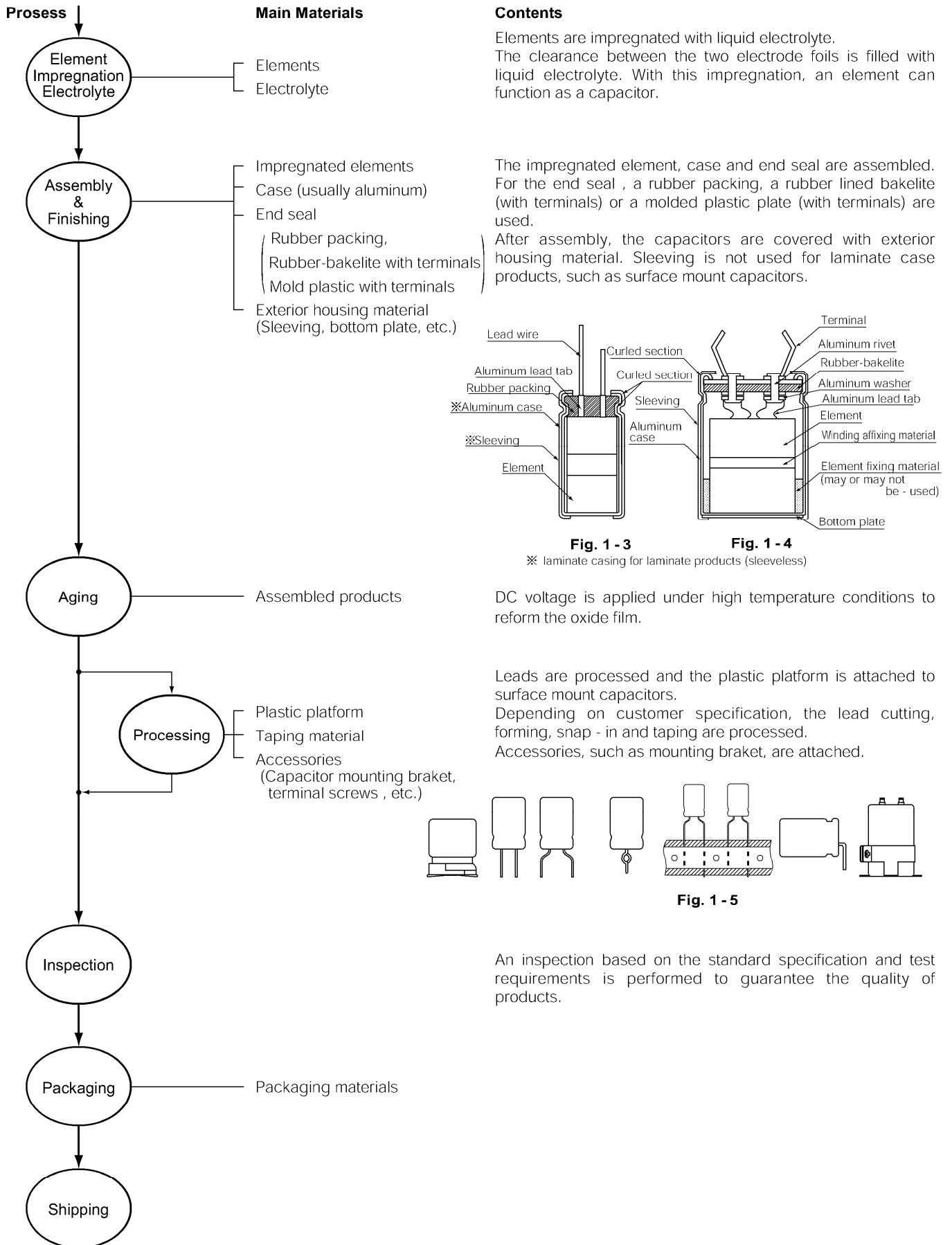

Fig. 1 - 2



1-6 Characteristics

1-6-1 Capacitance

The capacitance of the dielectric portion of the anode aluminum foil can be calculated with the following formula (discussed in 1-1) :

$$C_a = 8.855 \times 10^{-8} \cdot \frac{\epsilon}{d} \cdot F \dots$$

The cathode foil has a capacitance (Cc) that uses the oxide layer, which formed by the forming voltage or formed naturally during storage (generally 1V or less), as a dielectric. According to the construction of aluminum electrolytic capacitors, Ca and Cc are connected in a series. Therefore, the capacitance can be determined by the following formula:

$$C = \frac{C_a \times C_c}{C_a + C_c}$$

The standard capacitance tolerance is ±20%(M); however, capacitors with a capacitance tolerance of ±10%(K), etc. are also manufactured for special usage. The capacitance of aluminum electrolytic capacitors changes with temperature and frequency of measurement, so the standard has been set to a frequency of 120Hz and temperature of 20°C.

1-6-2 Equivalent Series Resistance (R), Dissipation Factor (tanδ), Impedance (Z)

The equivalent circuit of an aluminum electrolytic capacitor is shown below, The equivalent series resistance is also known as "ESR".

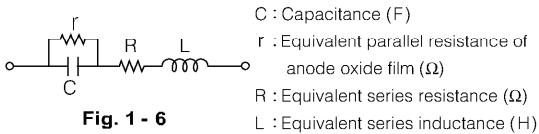

Fig. 1 - 6

A reactance value due to the equivalent series inductance "L" is extremely small at low frequencies (50Hz~1kHz) and can be regarded as zero. Therefore, the following formula can be set up.

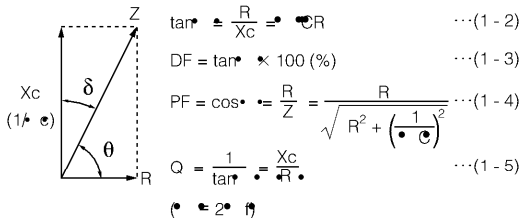

Fig. 1 - 7

The impedance can be expressed by :

$$Z = \frac{1}{j\omega C} + R$$

Its absolute value can be expressed by :

$$|Z| = \sqrt{R^2 + \left(\frac{1}{\omega C}\right)^2}$$

Its relation with frequencies is shown by a model curve.

The inductance "L" is mainly from the wound electrode foils and the leads.

ESR "R" is from resistance of the electrode foils, the electrolyte, the leads and each connection.

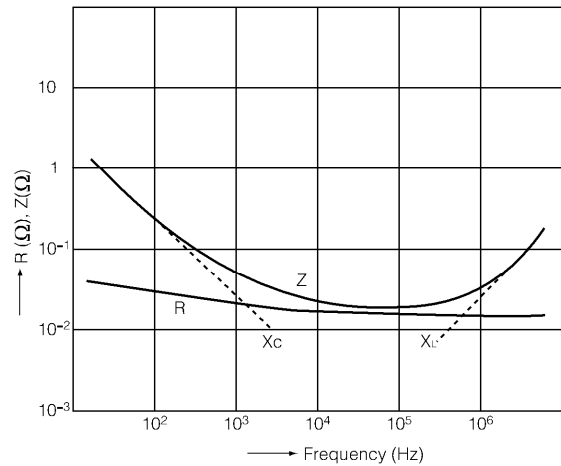

Fig. 1 - 8

1-6-3 Leakage Current

The causes of leakage current in aluminum electrolytic capacitors are listed below :

- 1)Distorted polarization of dielectric (aluminum oxide layer)
- 2)Resolution and formation of dielectric
- 3)Moisture absorption by dielectric
- 4)Breakdown of dielectric due to the existence of chlorine or iron particles.

The leakage current value can be decreased by proper selection of materials and production methods; however, cannot be totally eliminated.

Leakage current is also dependent upon time, applied voltage and temperature.

The specified leakage current value is measured after the rated voltage of the capacitor is applied at room temperature for a specified time period. When selecting a capacitor for a particular application, characteristics such as temperature dependency, aging stability and etc. must be taken into account.

1-6-4 Temperature Characteristics

Aluminum electrolytic capacitors have liquid electrolyte. This electrolyte has properties (conductivity, viscosity, etc.) that have rather conspicuous temperature characteristics.

Electrical conductivity increases as the temperature increases and reduces as the temperature decreases. Therefore, the electrical characteristics of aluminum electrolytics are affected by temperature more than other types of capacitors. The following section explains the relationship between temperature and capacitance, tangent delta, ESR, impedance and leakage current.

1) Capacitance

The capacitance of aluminum electrolytic capacitors increases as the temperature increases and decreases as the temperature decreases. The relationship between temperature and capacitance is shown in Fig. 1-9.

2) $\tan\delta$, Equivalent Series Resistance (ESR), Impedance

The $\tan\delta$, equivalent series resistance (ESR) and impedance changes with temperature and frequency. An example of the general characteristics is shown in Fig. 1-10 and 1-11.

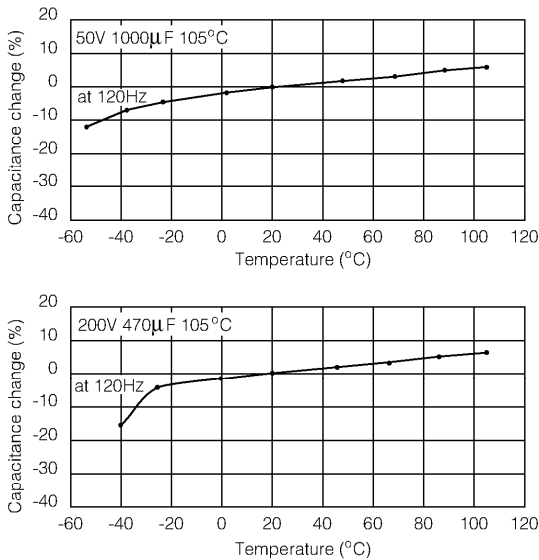

Fig. 1 - 9 Capacitance vs. Temperature Characteristics

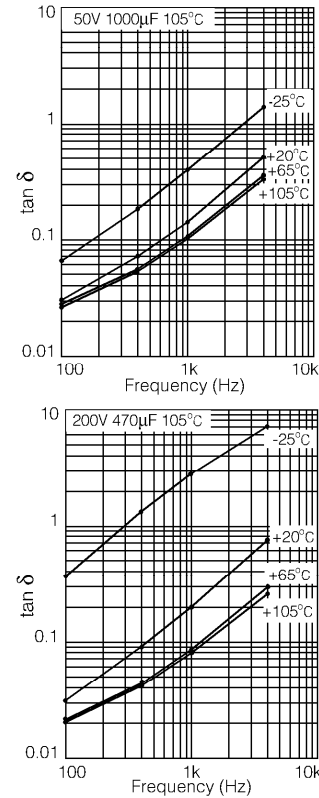

Fig. 1 - 10 $\tan\delta$ vs. Frequency Characteristics

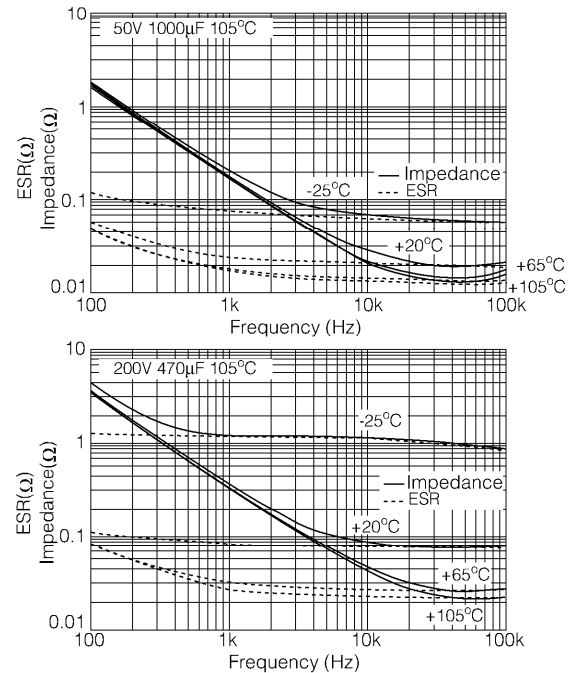

Fig. 1 - 11 Impedance, ESR vs. Frequency Characteristics

3) Impedance Ratio

The ratio between the impedance at 20°C and the impedance at various temperatures is called the impedance ratio. Impedance ratio becomes smaller as smaller change of ESR and capacitance with temperature. The quality of performance at low temperatures is particularly expressed with the impedance ratio at 120Hz.

4) Leakage Current

The leakage current increases as the temperature increases and decreases as the temperature decreases. Fig. 1-12 shows the relationship between temperature and leakage current.

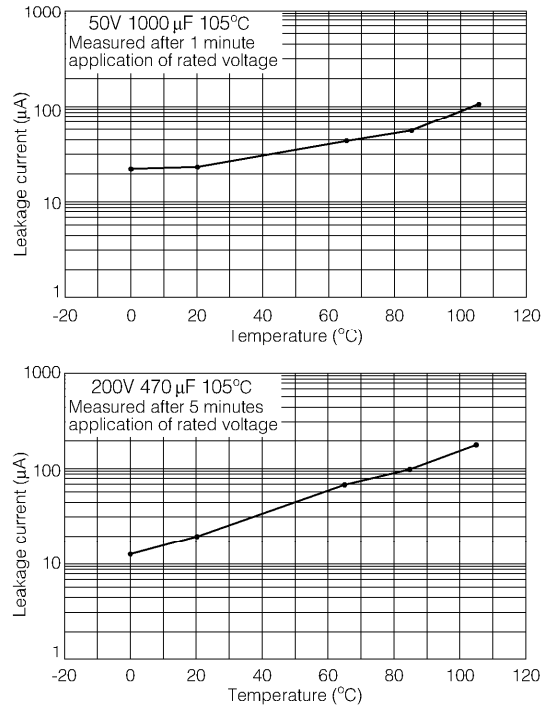

Fig. 1 - 12 Leakage current vs. Temperature Characteristic

2. Application Guidelines for Aluminum Electrolytic Capacitors

2-1 Application Guidelines

2-1-1. Circuit Design

- (1) Please make sure the application and mounting conditions to which the capacitor will be exposed are within the conditions specified in the catalog or alternate product specification (Referred as to specification here after).
 - ①The capacitor shall not be used in an ambient temperature which exceeds the operating temperature specified in the specification.
 - ②Do not apply excessive current which exceeds the allowable ripple current.
- (2) Operating temperature and applied ripple current shall be within the specification.
 - ①The capacitor shall not be used in an ambient temperature which exceeds the operating temperature specified in the specification.
 - ②Do not apply excessive current which exceeds the allowable ripple current.
- (3) Appropriate capacitors which comply with the life requirement of the products should be selected when designing the circuit.
- (4) Aluminum electrolytic capacitors are polarized. Make sure that no reverse voltage or AC voltage is applied to the capacitors. Please use bi-polar capacitors for a circuit that can possibly see reversed polarity.
Note: Even bi-polar capacitors can not be used for AC voltage application.
- (5) For a circuit that repeats rapid charging/discharging of electricity, an appropriate capacitor that is capable of enduring such a condition must be used. Welding machines and photo flash are a few examples of products that contain such a circuit. In addition, rapid charging/discharging may be repeated in control circuits for servomotors, in which the circuit voltage fluctuates substantially.
For appropriate choice of capacitors for circuit that repeat rapid charging/discharging, please consult Nichicon.
- (6) Make sure that no excess voltage (that is, higher than the rated voltage) is applied to the capacitor.
 - ①Please pay attention so that the peak voltage, which is DC voltage overlapped by ripple current, will not exceed the rated voltage.
 - ②In the case where more than 2 aluminum electrolytic capacitors are used in series, please make sure that applied voltage will be lower than rated voltage and the voltage will be applied to each capacitor equally using a balancing resistor in parallel with the capacitors.
- (7) Aluminum electrolytic capacitors must be electrically isolated as follows:
The aluminum case and the cathode foil are connected by the unstable resistance of a naturally formed oxide layer inside the aluminum case and the electrolyte.
 - ①(a) Case and negative terminal (except axial leaded part such as JIS configuration 02 type)
 - (b) Case and positive terminal
 - (c) Case and circuit pattern
 - ②(a) Auxiliary terminal of can type such as JIS style symbol 693, 694 or 695 and negative and positive terminal, including the circuit pattern.
 - ③Case and both terminals of a bi-polarized capacitor.
- (8)
 - ①Outer sleeve of the capacitor is not guaranteed as an electrical insulator. Do not use a standard sleeve on a capacitor in applications that require the electrical insulation. When the application requires special insulation, please contact our sales office for details.
 - ②Secondary shrinkage, bulging and/or crack could be seen on outer sleeve of capacitor when capacitors are kept in more than 2 minutes at 150°C ambient temperature during pre-heating at reflow process or resin curing process. Applying high temperature gas or heat ray to capacitor cause the same phenomenon. Further more, when temperature cycling test is performed beyond JIS standard (Temperature Cycles), aforementioned sleeve problem could be seen. Thus, please confirm their adaptation before the use.
- (9) Capacitors may fail if they are used under the following conditions:
 - ①Environmental (climatic) conditions
 - (a) Being exposed to water, high temperature & high humidity atmosphere, or condensation of moisture.
 - (b) Being exposed to oil or an atmosphere that is filled with particles of oil.
 - (c) Being exposed to salty water or an atmosphere that is filled with particles of salt.
 - (d) In an atmosphere filled with toxic gasses (such as hydrogen sulfide, sulfuric acid, nitrous acid, chlorine, bromine, methyl bromide, ammonia, etc.)
 - (e) Being exposed to direct sunlight, ozone, ultraviolet ray, or radiation
 - (f) Being exposed to acidic or alkaline solutions
 - ②Under severe conditions where vibration and/or mechanical shock exceed the applicable ranges of the specifications.
- (10) When designing a P.C. board, please pay attention to the following:
 - ①Have the hole spacing on the P.C. board match the lead spacing of the capacitor.
 - ②There should not be any circuit pattern or circuit wire above the capacitor pressure relief vent.
 - ③Unless otherwise specified, following clearance should be made above the pressure relief vent.

Case Diameter	Clearance Required
φ 6.3~16mm	2mm or more
φ 18~35mm	3mm or more
φ 40mm or more	5mm or more
 - ④In case the vent side is placed toward P.C. board (such as end seal vented parts), make a

corresponding hole on the P.C. board to release the gas when vent is operated. The hole should be made to match the capacitor vent position.

⑤ Screw terminal capacitors must be installed with their end seal side facing up. When you install a screw terminal capacitor in a horizontal position, the positive terminal must be in the upper position.

(11) The main chemical solution of the electrolyte and the separator paper used in the capacitors are combustible. The electrolyte is conductive. When it comes in contact with the P.C. board, there is a possibility of pattern corrosion or short circuit between the circuit pattern which could result in smoking or catching fire.

Do not locate any circuit pattern beneath the capacitor end seal.

(12) Do not design a circuit board so that heat generating components are placed near an aluminum electrolytic capacitor or reverse side of P.C. board (under the capacitor).

(13) Please refer to the pad size layout recommendations in our catalog when designing in surface mount capacitors.

(14) Electrical characteristics may vary depending on changes in temperature and frequency. Please consider this variation when you design circuits.

(15) When you mount capacitors on the double-sided P.C. boards, do not place capacitors on circuit patterns or over on unused holes.

(16) The torque for terminal screw or brackets screws shall be within the specified value on Nichicon's drawings.

(17) When you install more than 2 capacitors in parallel, consider the balance of current flowing through the capacitors. Especially, When a solid conductive polymer aluminum electrolytic capacitor and a standard aluminum electrolytic capacitor are connected in parallel, special consideration must be given.

(18) If more than 2 aluminum electrolytic capacitors are used in series, make sure the applied voltage will be lower than the rated voltage and that voltage will be applied to each capacitor equally using a balancing resistor in parallel with each capacitor.

2-1-2. Mounting

(1) Once a capacitor has been assembled in the set and power applied, Even if a capacitor is discharged, an electric potential (restriking voltage) may exist between the terminals.

(2) Electric potential between positive and negative terminal may exist as a result of returned electromotive force, so please discharge the capacitor using a 1kΩ resistor.

(3) Leakage current of the parts that have been stored for more than 2 years may increase. If leakage current has increased, please perform a voltage treatment using 1kΩ resistor.

(4) Please confirm ratings before installing capacitors on the P.C. board.

(5) Please confirm polarity before installing capacitors on the P.C. board.

(6) Do not drop capacitors on the floor, nor use a capacitor that was dropped.

(7) Do not damage the capacitor while installing.

(8) Please confirm that the lead spacing of the capacitor matches the hole spacing of the P.C. board prior to installation.

(9) Snap-in can type capacitor such as JIS style symbol 692, 693, 694 and 695 type should be installed tightly to the P.C. board (allow no gap between the P.C. board and bottom of the capacitor).

(10) Please pay attention that the clinch force is not too strong when capacitors are placed and fixed by an automatic insertion machine.

(11) Please pay attention to that the mechanical shock to the capacitor by suction nozzle of the automatic insertion machine or automatic mounter, or by product checker, or by centering mechanism.

(12) Hand soldering.

① Soldering condition shall be confirmed to be within the specification.

② If it is necessary that the leads must be formed due to a mismatch of the lead space to hole space on the board, bend the lead prior to soldering without applying too much stress to the capacitor.

③ If you need to remove parts which were soldered, please melt the solder enough so that stress is not applied to lead.

④ Please pay attention so that solder iron does not touch any portion of capacitor body.

(13) Flow soldering (Wave solder)

① Aluminum capacitor body must not be submerged into the solder bath. Aluminum capacitors must be mounted on the "top side" of the P.C. board and only allow the bottom side of the P.C. board to come in contact with the solder.

② Soldering condition must be confirmed to be within Nichicon specification.

Solder temperature: $260 \pm 5^{\circ}\text{C}$
Immersing lead time: 10 ± 1 second, Thickness of P.C. board : 1.6mm.

③ Please avoid having flux adhere to any portion except the terminal.

④ Please avoid contact between other components and the aluminum capacitor.

- (14) Reflow soldering (SMD only)
- ① Soldering condition must be confirmed to be within Nichicon specification.
 - ② When an infrared heater is used, please pay attention to the extent of heating since the absorption rate of infrared, will vary due to difference in the color of the capacitor body, material of the sleeve and capacitor size.
- (15) Soldering flux
- There are non-halogen types of flux that do not contain ionic halides, but contain many non-ionic halides. When these non-ionic halides infiltrate the capacitor, they cause a chemical reaction that is just as harmful as the use of cleaning agents. Use soldering flux that does not contain non-ionic halides.
- (16) Shrinkage, bulging and/or cracking could be seen on the outer sleeve of the capacitor when capacitors are kept in for more than 2 minutes at 150°C ambient temperature during soldering at reflow process or resin curing process. Applying high temperature gas or heat ray to capacitor can cause the same phenomenon.
- (17) Do not tilt lay down or twist the capacitor body after the capacitor are soldered to the P.C. board.
- (18) Do not carry the P.C. board by grasping the soldered capacitor.
- (19) Please do not allow anything to touch the capacitor after soldering. If P.C. board are stored in a stack, please make sure P.C. board or the other components do not touch the capacitor.
The capacitors shall not be effected by any radiated heat from the soldered P.C. board or other components after soldering.
- (20) Cleaning Agent, Fixing material, Coating material
Please refer to the section 2-10-2, -3 for Cleaning agent, fixing material and coating material.
- (21) Fumigation
Please refer to the section 2-10-4 for others.

3. In the equipment

- (1) Do not directly touch terminal by hand.
- (2) Do not short between terminals with conductor, nor spill conductible liquid such as alkaline or acidic solution on or near the capacitor.
- (3) Please make sure that the ambient conditions where the set is installed will be free from spilling water or oil, direct sunlight, ultraviolet rays, radiation, poisonous gases, vibration or mechanical shock.

4. Maintenance Inspection

- (1) Please periodically inspect the aluminum capacitors that are installed in industrial equipment. The following items should be checked:
 - ① Appearance : Remarkable abnormality such as

- vent operation, leaking electrolyte etc.
- ② Electrical characteristic: Capacitance, dielectric loss tangent, leakage current, and items specified in the specification.

5. In an Emergency

- (1) If you see smoke due to operation of safety vent, turn off the main switch or pull out the plug from the outlet.
- (2) Do not bring your face near the capacitor when the pressure relief vent operates. The gasses emitted from that are over 100°C.
If the gas gets into your eyes, please flush your eyes immediately in pure water.
If you breathe the gas, immediately wash out your mouth and throat with water.
Do not ingest electrolyte. If your skin is exposed to electrolyte, please wash it away using soap and water.

6. Storage

- (1) It is recommended to keep capacitors between the ambient temperatures of 5°C to 35°C and a relative humidity of 75% or below.
- (2) Confirm that the environment does not have any of the following conditions:
 - ① Where capacitors are exposed to water, high temperature & high humidity atmosphere, or condensation of moisture.
 - ② Where capacitors are exposed to oil or an atmosphere that is filled with particles of oil.
 - ③ Where capacitors are exposed to salty water, high temperature & high humidity atmosphere, or condensation of moisture.
 - ④ The atmosphere is filled with toxic acid gasses (e.g. hydrogen sulfide, sulfurous acid, nitrous acid, chlorine, bromine, methy bromide, etc.)
 - ⑤ The atmosphere is filled with toxic alkaline gasses (e.g. ammonia)
 - ⑥ Where capacitors are exposed to acidic or alkaline solutions.

7. Disposal

- (1) Take either of the following methods in disposing of capacitors.
 - ① Make a hole in the capacitor body or crush capacitors and incinerate them.
 - ② If incineration is not applicable, hand them over to a waste disposal agent and have them buried in a landfill.

The above mentioned material according to EIAJ RCR - 2367B (issued in March, 2002), titled "Guideline of notabilia for aluminum electrolytic capacitors for use in electronic equipment".
Please refer to the book for details.

2-2 Failure Modes of Aluminum Electrolytic Capacitors

2-2-1 Definition of Failure

The following two conditions must be considered in defining "failure."

1) Catastrophic failure

When a capacitor has completely lost its function due to a short or open circuit.

2) Degradation failure

The gradual deterioration of a capacitor. In the case of a degradation failure, the criteria for failure differs according to the use of a capacitor. Capacitor requirements vary depending on the type of finished products. Therefore, the specified value in the specification is used as the judging criteria.

2-2-2 Failure Mode in the Field

1) Short Circuit

Short circuits in the field are very rare. A short circuit between the electrodes can be caused by vibration, shock and stress on leads. It can also be caused by application of voltage above the rated voltage, application of extreme ripple or by application of pulse current.

2) Open Circuit

- An open circuit can be caused if extreme force is applied to the capacitor at the time of mounting and if vibration / shock is then applied during usage. In such cases, the connection between the lead wire and tab could be distorted or twisted which eventually leads to an open circuit.
- If halogen is used as a cleaning agent for P.C. boards and a fixing agent (including conformal materials) for capacitors, infiltrates the capacitor, the operation of the circuit may be affected by an increased leakage current as a result of an open circuit due to corrosion of lead wires, foils and tabs.
- The electrolyte may vaporize and cause an open circuit if the tightness of the seal is broken as a result of sealing material deterioration due to use under high temperature exceeding the rated maximum operating temperature, or exposure to high heat transmitted through the P.C. board patterns, or prolonged use.
- If the sealing material ages due to long term usage. When subjected to such conditions, there is a possibility that the capacitor will open circuit due to drying of electrolyte.
- If an improper amount of ripple is applied, the internal temperature will rise. This will cause the electrolyte to increase its internal gas pressure and permeate through the end seal material. As a result of drying of electrolyte, open circuit will occur.

3) Capacitance Drop, High Loss (High ESR)

If the capacitor is subjected to the following conditions, capacitance drop and high loss takes place: 1) if reverse voltage is continuously applied, 2) if a current exceeding the maximum rated ripple is applied, and 3) if the capacitor is subjected to extreme recharge and discharge.

4) Destruction (Pressure Relief Vent Operation)

The pressure relief vent may operate due to generation of gas caused by reverse voltage, over voltage, extreme ripple or AC voltage.

2-2-3 Analysis of Failure Mode

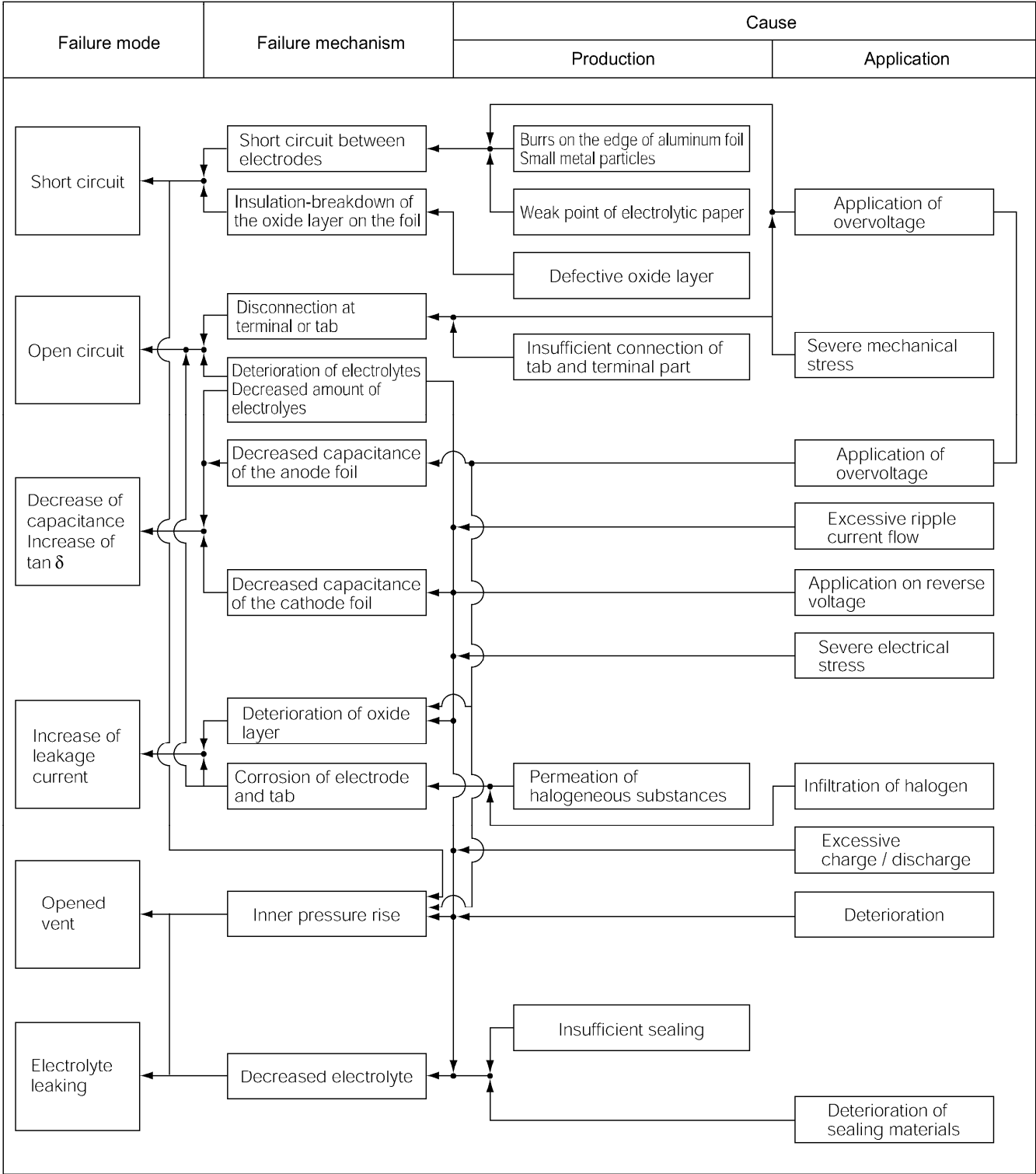

Fig. 2 - 1 Analysis of Failure Mode

2-3 Operating Voltage and Safety

2-3-1 Foreword

The relationship between the voltage and leakage current when voltage is applied to the aluminum electrolytic capacitor is shown in Fig. 2-2. From Fig. 2-2, the following can be said:

- If voltage is applied in directions of the polarity of the capacitor, the leakage current will start rapidly to rise if the applied voltage exceeds the rated voltage.
- If voltage is applied in reverse direction of the polarity of the capacitor, a large amount of current begins to run through with a low voltage.

The behavior and safety test method of the aluminum electrolytic capacitor, which withholds the above nature, under the below conditions is expressed in the following section.

- 1) Under reverse polarity
- 2) Under excess voltage application.
- 3) Under AC voltage application

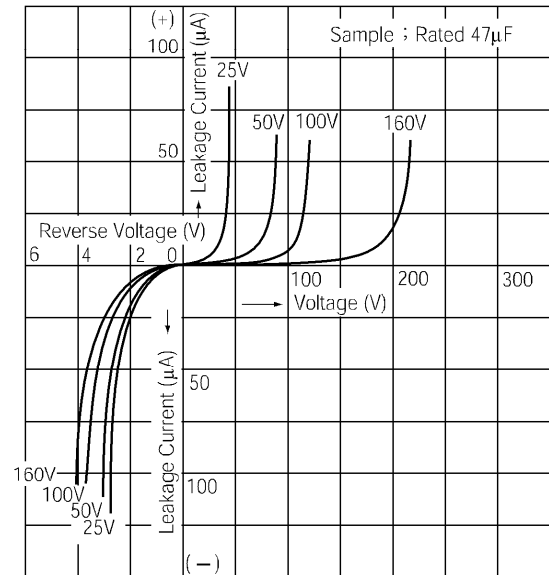

Fig. 2-2 V - I Characteristics (Voltage - Current Characteristics)

2-3-2 Reverse Voltage

The state of the capacitor changes according to the degree of reverse voltage applied.

- 1) If high reverse voltage is applied, the current will increase. Heat will generate due to power loss ($W = V_c \times I_c$) caused by reverse voltage (V_c) and current (I_c). Heat caused by current and gas that generated due to the electrolytic dissociation of electrolyte will increase the inner pressure of the capacitor and activate the vent in a short period of time.
- 2) In case of a low reverse voltage and a low leakage current, a capacitor initially generated heat due the power loss. But the progressing formation of an oxide layer on the cathode electrode causes a decrease in current. Fig. 2-3 shows how the capacitance changes relative to the application of reverse voltage. The results shown in the figure is due to the decrease in cathode foil capacitance caused by oxide layer formation on the surface of the cathode aluminum foil. Again due to the consumption of electrolyte, the $\tan \delta$ increases.

Normally a cathode foil has a withstand voltage of about 1V because of the natural oxide layer so it can withstand a reverse voltage as much as a diode's withstand reverse voltage. If the capacitor is being used a reverse voltage over the withstand voltage, the internal pressure will rise and activate the pressure relief vent. Please make sure to check the polarity of the capacitors before usage.

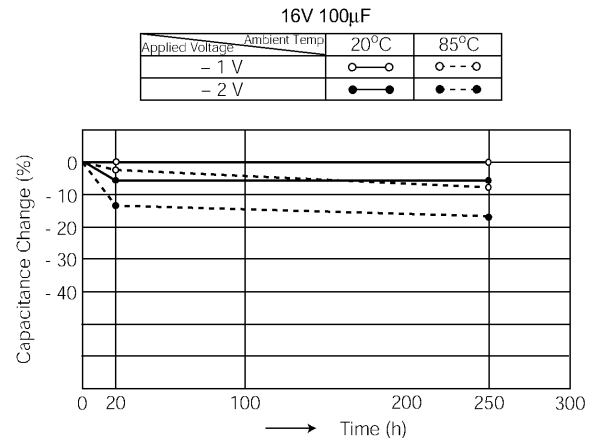

Fig. 2-3 Capacitance vs. Reverse Voltage Characteristics

2-3-3 Excess Voltage Application

As Fig. 2-4 shows, the leakage current rises sharply when voltage above the rated voltage is applied. When the withstand voltage of the anode foil decreases due to the generation of heat and the anode foil undergoes insulation breakdown, a large amount of current will flow through and cause the internal pressure to rise within a short period of time. If the pressure relief vent is activated, the electrolyte that has changed to gas is vigorously released from the opened vent. The energy of the capacitor is proportional to the second power of the voltage ($J = \frac{1}{2} CV^2$). Therefore, the higher the applied voltage, the more severe the condition of the activated vent, and the more likely that a short between the foils will occur. Please use capacitors within their rated voltage.

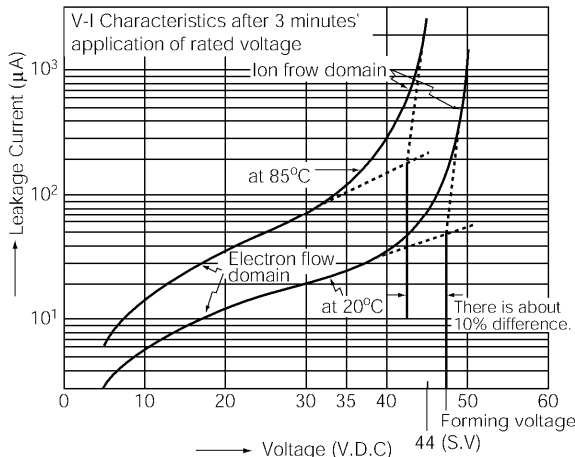

Fig. 2-4 V-I Characteristics (ex. Rated at 35V)

2-3-4 AC Voltage Application

If AC voltage is applied to an aluminum electrolytic capacitor, an electric current of $I = \omega CE$ (A) flows.

As (Fig. 2-2 V-I Characteristics) shows, the aluminum electrolytic capacitor does not have withstand voltage in the reverse direction. Therefore if the capacitor is used in an AC circuit, an electric current flow which is larger than that calculated from $I = \omega CE$. If the internal resistance of the aluminum electrolytic capacitor is labeled R (Ω), heat will generate due to the wattage loss $W = I^2R$ (W) according to the current. The degree of heat is large because the internal resistance of a capacitor is large; thus the pressure relief vent is activated when heat generates and causes the electrolyte to evaporate, causing the internal pressure to rise. Even bipolar capacitors (non-polar), cannot use it for continuous AC application in addition to above.

2-3-5 Pressure Relief Vent Structure

The internal pressure of the capacitor will rise due to gas generation caused by heat generation, evaporation of electrolyte or electrolytic dissociation if the following is applied : extreme voltage, reverse voltage, AC current or extreme ripple. With this in mind, the pressure relief vent is provided to release internal pressure.

There are two types of pressure relief vents classified by their location on the capacitor : 1) end seal, 2) aluminum case.

Testing Method

a. AC Voltage Method (JIS C5101-1, 4.28.1)

(1)In the circuit shown in Fig.2-5 a series resistance "R" is selected from Table 2-1 in accordance with the rated capacitance of the capacitor to be tested.

Table 2-1

Rated Capacitance (μ F)	Series Resistance (Ohm)	Rated Capacitance (μ F)	Series Resistance (Ohm)
1 or below	1000±100	Over 100~1000	1±0.1
Over 1~10	100±10	Over 1000~10000	0.1±0.01
Over 10~100	10±1	Over 10000	Note 1

Note 1 : A resistance value equivalent to 1/2 of impedance at testing frequency.

(2)The capacitor is connected and AC voltage is applied as high as 70% of the rated voltage or 250Vrms, whichever is smaller. However, when 30Arms or more is applied, the voltage must be adjusted so that the maximum applied current is 30 Arms. The power source frequency is either 50Hz or 60Hz.

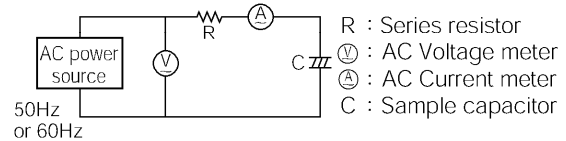

Fig. 2-5

b. DC Reverse Voltage Method (JIS C5101-1, 4.28.2)

(1)For the circuit shown in Fig.2-6, DC current is selected from Table 2-2 according to the nominal diameter of the capacitor to be tested.

Table 2-2

Nominal Diameter (mm)	DC Current (A)
22.4mm or less	1A constant
Over 22.4mm	10A constant

(2)The capacitor is connected with its polarity reversed to a DC power source. Then a current selected from Table 2-2 is applied.

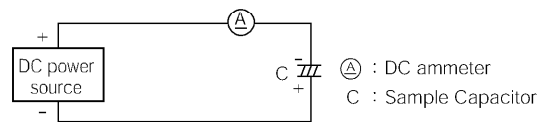

Fig. 2-6

Judging Criteria

If the results of the prior tests show the following conditions, the safety vent has passed the test.

- (1) The vent operates with no dangerous conditions such as flames or dispersion of pieces of the capacitor element and/or case.
- (2)Nothing abnormal takes places even if the test voltage has been applied to the capacitor for 30 minutes.

2-4 Charging and Discharging

2-4-1 Effect of Charging and Discharging

Following are the phenomenon that occurs in the aluminum electrolytic capacitor, when used in a frequent charge/discharge circuit such as shown in Fig. 2-7.

In the circuit shown in Fig. 2-7, when the polarized aluminum electrolytic capacitor, which consists anode foil capacitance (Ca) and cathode foil capacitance (Cc), is charged with voltage (V), anode foil dielectric is charged with electrical charge of $Q = Ca \times V$ (C: coulomb). Next when discharges electrical charge through discharge resistance, electrical charge of anode foil moves and charges cathode foil. Since withstand voltage cathode foil dielectric is low, cathode foil reaches its withstand voltage by a part of electrical charge which moves from anode foil. When electrical charge moves continuously, electro-chemical reactions occur at interface between cathode foil surface and electrolyte. If charge and discharge are repeated, another dielectric layer is formed on the dielectric layer of the cathode foil. Cathode foil capacitance gradually decreases as additional dielectric layer is formed. Capacitance value of the capacitors decreases as the cathode foil capacitance decreases. The gas generated during oxide layer formation accumulates inside of the capacitor, and rises internal pressure. Depending upon the charge and discharge conditions, pressure relief vent may activate.

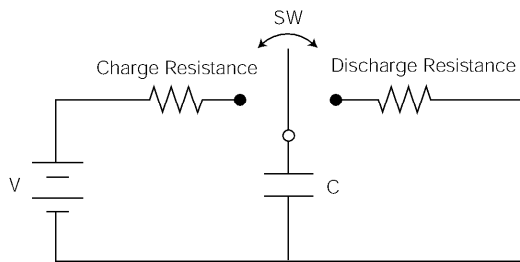

Fig. 2 - 7

2-4-2 Formation of the Oxide Layer

The voltage applied to the cathode foil during discharge is explained as follows.

Electrical charge of the anode foil moves until anode foil voltage and cathode foil voltage become equal (direction of voltage are opposite to each other and voltage between terminal is zero).

The following formula can be set, using anode foil capacitance (Ca), the initial cathode foil capacitance (Cc), discharge voltage (V), and the voltage applied to anode and cathode foil after discharging (Vc).

$$Ca \times V = Ca \times Vc + Cc \times Vc$$

$$\therefore Vc = \frac{Ca}{Ca + Cc} \times V \dots\dots\dots (2 - 1)$$

From the above, when considering usage of an aluminum electrolytic capacitor in a circuit that will repeat frequent charge and discharge, it is recommended to use capacitors designed to specifically meet conditions of frequent charge/discharge.

2-4-3 Measures Taken Against frequent Charge / Discharge

The following measures are taken to prevent an oxide layer formation on the cathode foil.

- ① Using a cathode foil with a formation of dielectric layer over the Vc voltage expected.
- ② The following Equation 2-2 led from Equation 2-1; Equation 2-2 shows that the greater the ratio between the capacitance of anode and capacitance of cathode foil, which is Cc / Ca , the smaller the Vc. From this, the Vc is made smaller than the forming voltage of the cathode foil by using a cathode foil with a sufficient (big enough) capacitance against the anode foil capacitance.

$$Vc = \frac{V}{1 + \frac{Cc}{Ca}} \dots\dots\dots (2 - 2)$$

Fig.2-8 shows examples of results, after the charge/discharge test, found in the charge / discharge type capacitor and standard capacitor.

Capacitance : 63V 10000uF
 Charge resistance : 2Ω
 Discharge resistance : 100Ω
 Charge/discharge cycle : 1 second of charge, 1 second of discharge is 1 cycle.
 Temperature : 70°C

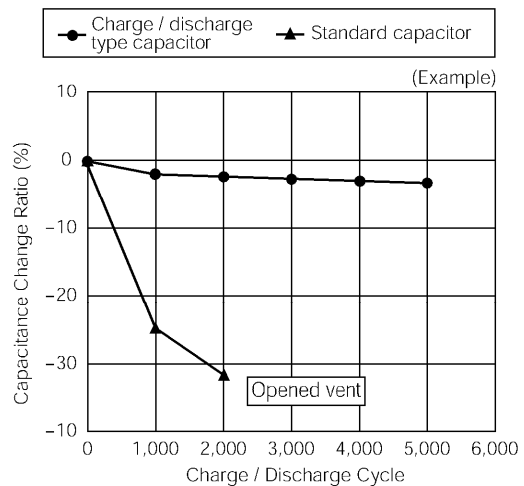

Fig. 2 - 8

If the application is a circuit that has large fluctuations in voltage, such as a power supply for an AC servo amplifier or an inverter, select a QS,QR series capacitor that allows rapid charging and discharging. QS,QR series capacitors employ a special structure to increase their durability against rapid charging and discharging. (Patent pending)

2-5 Method of Setting the Balance Resistance in a Series Connection

2-5-1 Equivalent Circuit and Leakage Current

The relationship between the balance resistance and leakage current resistance of aluminum electrolytic capacitors used in a series circuit, expressed in an equivalent circuit, is shown in Fig. 2-9.

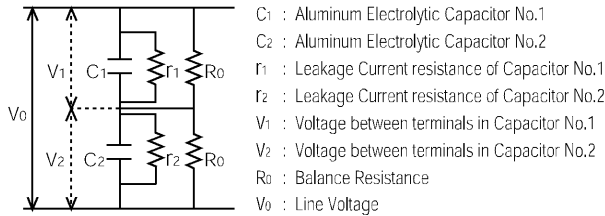

Fig. 2-9

If the leakage current of C_1 and C_2 are expressed as i_1 and i_2 :

$$i_1 = \frac{V_1}{r_1}, \quad i_2 = \frac{V_2}{r_2} \dots\dots\dots (2-3 \cdot 2-4)$$

$$V_0 = V_1 + V_2, \quad V_1 - V_2 = R_0 \times (i_2 - i_1)$$

$$R_0 = \frac{V_1 - V_2}{i_2 - i_1} \dots\dots\dots (2-5)$$

2-5-2 Leakage Current of the Aluminum Electrolytic Capacitor

If the rated voltage is expressed as V (V) and the capacitance as C (μ F), variation of the leakage current in a PC board mounting type capacitor at room temperature can be generally expressed by the following equation:

$$\begin{aligned}
 i_{\max} - i_{\min} &= \frac{\sqrt{C \times V}}{2} - \frac{\sqrt{C \times V}}{5} \\
 &= \sqrt{C \times V} \left(\frac{1}{2} - \frac{1}{5} \right) \\
 &= \frac{3}{10} \sqrt{C \times V} \dots (\mu A) \dots\dots\dots (2-6)
 \end{aligned}$$

The leakage current of aluminum electrolytic capacitors increases as the temperature rises.

Generally if the leakage current at 20°C is referred to as 1, it becomes 2~3 times at 65°C and 3~5 times at 85°C. The leakage current also differentiates depending on the applied voltage and storage conditions, so it is necessary to multiply the leakage current variation coefficient to give a little leeway.

2-5-3 Example of Setting the Balance Resistance

The following shows the equation method for setting the balance resistance in using 2 (pcs) of 400V, 470 μ F aluminum electrolytic capacitors in a series circuit within an ambient temperature of 60°C.

- Temperature coefficient for leakage current at 60°C: 2.0
- Voltage balance rate: 10%
- Coefficient for variation of leakage current: 1.4

Voltage balance

$$V_1 - V_2 = 400 \times 0.1 = 40 \text{ (V)}$$

Range of leakage current variation:

$$\begin{aligned}
 i_{\max} - i_{\min} &= \frac{3}{10} \sqrt{C \times V} \times 2 \times 1.4 \\
 &= \frac{3}{10} \sqrt{470 \times 400} \times 2 \times 1.4 \\
 &= 364 \text{ (}\mu A)
 \end{aligned}$$

$$\therefore R_0 = \frac{40}{364 \times 10^{-6}} \approx 109000 \dots\dots\dots 100k\Omega$$

When setting the balance resistance, we recommend consideration of the method that is currently used as well.

2-6 Storage Performance

When an aluminum electrolytic capacitor is stored under no load conditions for a long period of time, its leakage current tends to increase slightly. This is due to a drop in the withstand voltage of the dielectric caused by the reaction of the anode oxide layer with the electrolyte. When the voltage is applied to the capacitor, the leakage current returns to its initial level because of the re-forming action of the electrolyte (called voltage treatment). If the storage temperature is high, the leakage current will increase substantially. Therefore, it is desirable to store capacitors at normal temperature level with no direct sunlight. A voltage treatment is recommended when using a capacitor stored for a long period of time. The treatment for an individual capacitor is accomplished by charging up to its rated voltage through a resistance of about 1 kΩ and applying the voltage for approximately 30 minutes. When a capacitor is already built into an appliance, the

appliance must undergo aging. If the input voltage is adjustable or the power supply that supplies power to a module, first set the voltage to a low value (approximately half the rated voltage) and let it run for about ten minutes. Then, increase the voltage to the appropriate value little by little while monitoring the working of a device.

If the voltage is not adjustable, turn on the switch and let it run for about thirty minutes while confirming if the device complies with the specifications. Then turn off the switch before using the capacitor for practical applications.

Generally, if the capacitor has been stored within 2 years in the storage temperature range of 5~35°C, the capacitor can be used without voltage treatment.

Fig. 2-10 shows an example of the characteristic change in capacitors that were stored at normal temperatures.

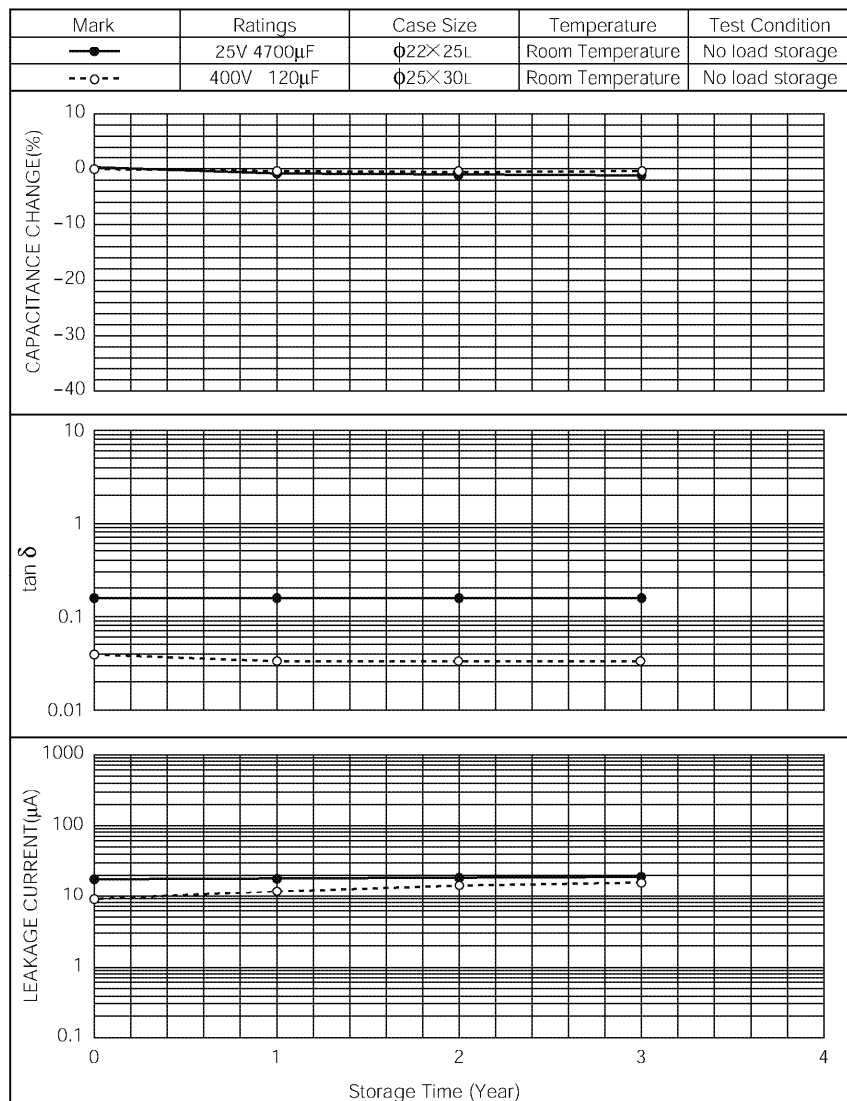

Fig. 2 - 10

2-7 Restriking-voltage

Aluminum electrolytic capacitors are discharged completely after inspection before shipping. Even if the capacitor has been discharged, voltage still appears between the terminals. This voltage is called restriking-voltage or remaining voltage.

By polarization phenomena, the surface of dielectric is charged positively and negatively respectively when voltage is applied to the capacitor. Then terminals are shorted, electrical charge at the surface discharges and loose electricity. However, terminals are opened, some voltage appears between terminals because dipole that had polarized and remained in the dielectric polarized again. This is what is referred to as the restriking-voltage. Restriking-voltage relates to the thickness of the dielectric. so it increases as the rated voltage becomes larger. When restriking-voltage occurs, electrical sparks may occur when a capacitor is installed to the circuit and surprise operator or destroy other low voltage disturbance elements. If there is fear that such situations may occur, it is recommended to discharge the accumulated electricity by connecting the terminals with a resistor that has a resistance of 100Ω~1 kΩ before usage. As for the capacitors of high voltage and large capacitance, packaging method that enable to short between terminals by aluminum foil or electrical conductive rubber, may be available. If such packaging is necessary, please contact our sales offices.

2-8 Usage at High Altitudes

Here are precautions in using aluminum electrolytic capacitors at high altitudes, such as in mountainous regions and in aircrafts.

As the altitude rises, the air pressure decreases. Therefore, if the capacitor is used at high altitudes, the atmospheric pressure becomes lower than the internal pressure of the capacitor. Due to the construction of the aluminum electrolytic capacitor, there is no concern in using them at altitudes lower than about 10,000 (m).

However, if the altitude rises, the temperature decreases. If the temperature of the capacitor decreases, the capacitance level drops, the tangent delta increases. Due to such factors, we recommend checking the performance of the electrical equipment at different temperatures.

Table 2-3 Relationship Between Altitude, Temp. and Air Pressure

Altitude (m)	Temp.(°C)	Air Pressure (hPa)
0	15.0	1013.3
2,000	2.0	795.0
4,000	- 11.0	616.4
6,000	- 24.0	471.8
8,000	- 37.0	356.0
10,000	- 50.0	264.4
20,000	- 56.5	54.7

For more details, please contact our sales offices.

2-9 Life and Reliability

2-9-1 Foreword

The failure rate (λ) for electronic applications and components which require no particular maintenance follows their time transition (t) and shows a curve as shown in Fig.2-11. Because this curve resembles the shape of a western bathtub, it is called "Bathtub Curve." The failure mode of aluminum electrolytic capacitors also forms a "Bathtub Curve." If the results of the life evaluation test of aluminum electrolytic capacitors is analyzed by "Weibull Probability Paper" as in Fig. 2-12, the shape parameter "m" is larger than 1, showing that the failure mode is a wear-out failure. Although the failure rate or the life estimation is generally used in designing a device, the reliability of an aluminum electrolytic capacitor is generally measured by its life (the expected life, in practical use) rather than failure rate since the failure mode of aluminum electrolytic capacitors is wear-out. In other words it is expected that we have different failure rates in the same test time (number of specimens x test time) (e.g. 100 capacitors x 10 hours... zero failures is expected, 10 capacitors x 10 hours... 100% will be failed). The factors that most effect the life of aluminum electrolytic capacitors are acceleration according to the ambient temperature (F_T), acceleration according to the ripple current (F_I) and acceleration according to the applied voltage (F_U). The expected life is calculated by multiplying the specified life time on Nichicon catalog, F_T , F_I , and F_U . The life of aluminum electrolytic capacitors is discussed in the following.

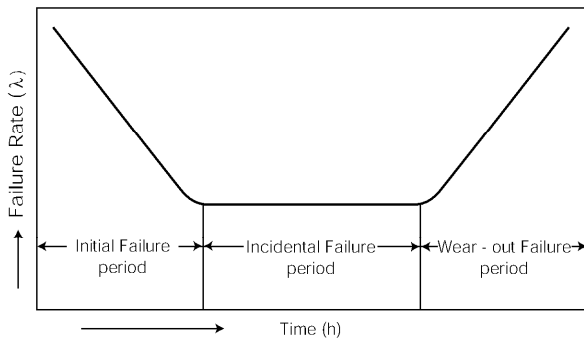

Fig. 2 - 11 Failure Rate Curve (Bathtub Curve)

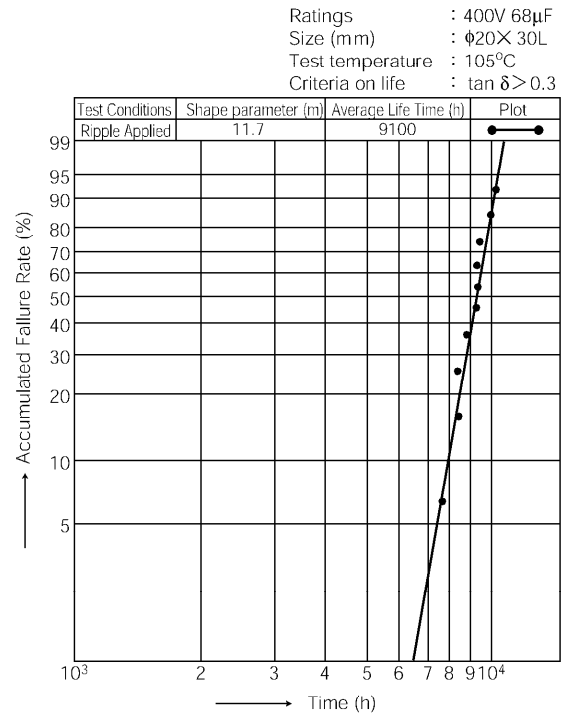

Fig. 2 - 12 Failure Analysis by Weibull Probability Paper

2-9-2 Life Evaluation Method

An aluminum electrolytic capacitor is determined to have reached its end of life when the capacitance change, tan δ and leakage current have exceeded the specified value or when a noticeable external abnormality occurs. Factors that effect the life of aluminum electrolytic capacitors are temperature, humidity and vibration, etc., but the factor that has the most effect is the temperature, which shortens the life as the temperature rises. From this, life tests are determined by applying the DC voltage or by applying ripple superimposed upon DC voltage at the specified maximum operating temperature of the capacitor. Examples of the test results are shown in Fig. 2-13 and 2-14.

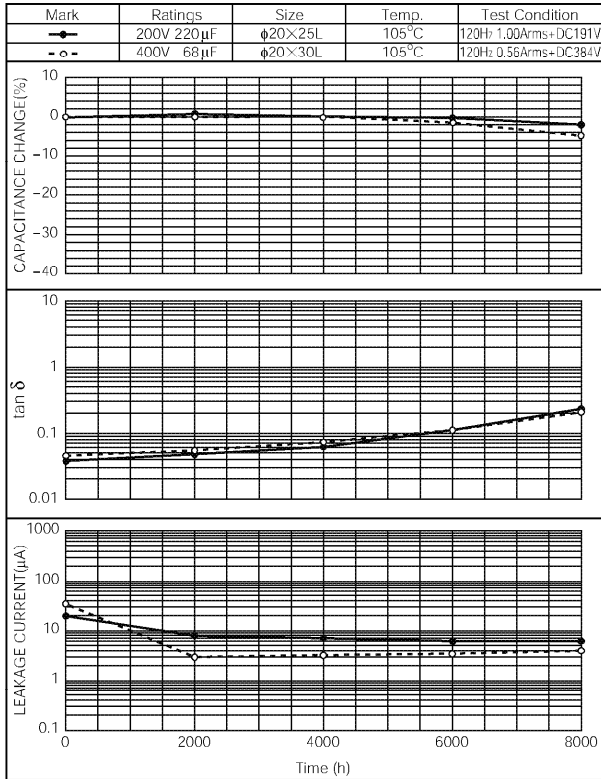

Fig. 2-13 High Temperature Life Evaluation Test

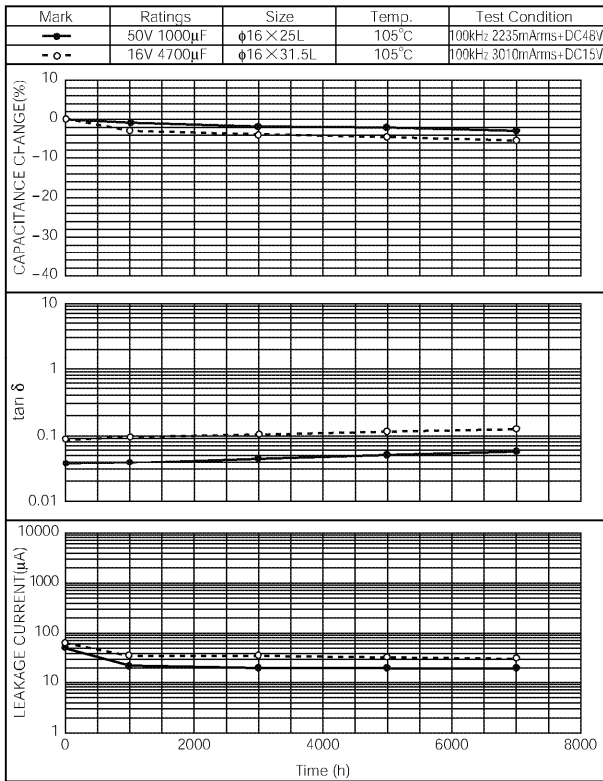

Fig. 2-14 High Temperature Life Evaluation Test

2-9-3 Ambient Temperature and Life

In general, but not necessarily in all cases, if a capacitor

is used at the maximum operating temperature or below (generally to a minimum of plus 40 $^{\circ}$ C operating temperature) life expectancy can be calculated according to Arrhenius theory in which the life doubles for each 10deg C drop in temperature. Refer to Fig 2-15 showing the expected life.

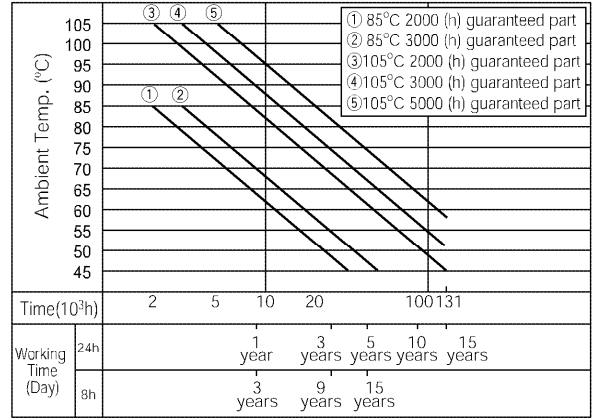

Fig. 2-15 Life Estimation Table

2-9-4 Applied Voltage and Life

The degree that applied voltage effects the life of the capacitor when used below the rated voltage is small, compared to the degree that ambient temperature and ripple current effects life. Therefore, when estimating the life of a capacitor, the voltage coefficient to the applied voltage (F_u) is calculated as 1. An example of the test results is shown in Fig.2-16.

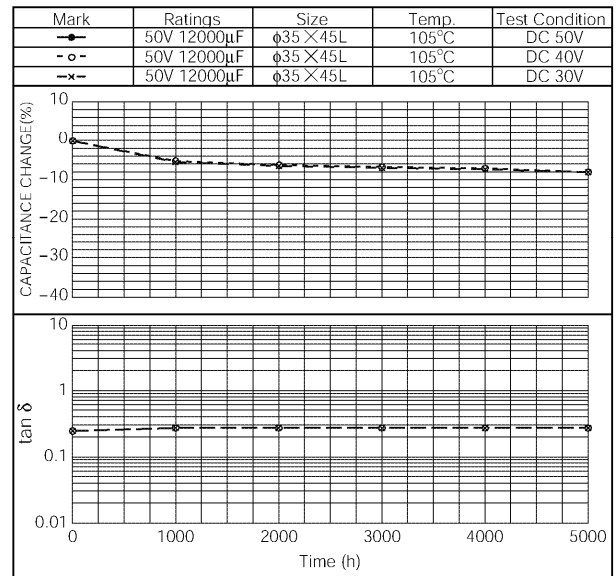

Fig. 2-16 High Temp. Evaluation Test When Applied Voltage is Charge

In regards to high voltage capacitors used in smoothing circuits for power electronic equipment, the leakage current decreases as the voltage drops and lessens the consumption of electrolyte. In such cases, the life of the capacitor may be extended. For more details, please contact our sales offices.

2-9-5 Ripple Current and Life

The tan δ of the aluminum electrolytic capacitor is larger than other types such as film capacitors, and heat generates inside electrolytic capacitors due to power loss when ripple current is applied. Heat generation effects the life of the capacitor because it causes a temperature rise.

1) Ripple Current and Heat Generation

The power loss due to ripple current being applied along with a DC voltage can be calculated by the following formula :

$$W = W_{AC} + W_{DC}$$

$$W = I_{AC}^2 \times R_e + V_{DC} \times I_{DC} \dots (2-7)$$

- W : Consumption of electricity by the capacitor (W)
- W_{AC} : Power loss due to ripple current (W)
- W_{DC} : Power loss due to DC (W)
- I_{AC} : Ripple current (A)
- R_e : E.S.R. of the capacitor
- V_{DC} : DC Voltage (V)
- I_{DC} : Leakage Current (A)

If the DC voltage is below the rated voltage, the leakage current is extremely small and becomes W_{AC} >> W_{DC}. From this, power loss can be calculated by the following formula :

$$W = I_{AC}^2 \times R_e \dots (2-8)$$

The external temperature of the capacitor rises to a point where the internal heat generation balances with the heat radiation. The temperature rise up to a balance point can be given by the following formula:

$$I_{AC}^2 \times R_e = \beta \times A \times \Delta t \dots (2-9)$$

$$\Delta t = \frac{I_{AC}^2 \times R_e}{\beta \times A} \dots (2-10)$$

- β : Heat Radiation Constant (10⁻³W / °C·cm²)
- A : Surface Area (cm²)

When the size of the capacitor is φ D × L :

$$A = \frac{\pi}{4} D (D + 4L) \dots (2-11)$$

The surface area can be figured from the above equation.
Δt = Temperature rise of ripple (°C)

The relationship between internal resistance "Re," capacitance "C" and tanδ is as follows :

$$R_e = \frac{\tan \delta}{\omega C} \dots (2-12)$$

However, according to $\alpha = \frac{\Delta t_s}{\Delta t_c}$ $\dots (2-13)$

$$\Delta t = \frac{I_{AC}^2 \times R_e}{\beta \times A} = \frac{I_{AC}^2 \times \tan \delta}{\beta \times A \times \omega C} \dots$$

The heat radiation constant (β) and temperature rise multiplier, which is temperature rise ratio calculated by temperature rise at the surface Δts divided by at the core of element Δtc and is expressed as α, is as shown in Table 2-4.

Table 2-4

Case dia (mm)	5 or less	6.3	8	10	12.5	16	
β	2.18	2.16	2.13	2.10	2.05	2.00	
α	1.0		0.94	0.90	0.85	0.80	
	18	20	22	25	30	35	40
	1.96	1.93	1.88	1.84	1.75	1.66	1.58
	0.77	0.75	0.74	0.71	0.67	0.64	0.62

α : Temperature rise ratio calculated α = Δts/Δtc
β : Heat radiation constant (10⁻³W / °C·cm²)

2) Frequency Coefficient of Allowable Ripple Current

Equivalent series resistance of aluminum electrolytic capacitor (Re) is frequency dependence. Higher the frequency, lower the ESR. Assuming that temperature rise due to ripple current at a frequency of (fx) and at a frequency of (fo) are same, when (Ro) is ESR at a frequency of (fo) and (Rx) is ESR at a frequency of (fx). The following equation would be set.

$$I_o^2 \times R_o = I_x^2 \times R_x$$

$$\therefore I_x = \sqrt{\frac{R_o}{R_x}} \times I_o \dots (2-14)$$

Thus, $\sqrt{R_o/R_x}$ becomes the frequency coefficient Kf. Table 2-5 shows examples of frequency coefficients.

Table 2-5 Frequency coefficient of allowable ripple current <Example>

• Snap-in terminal type capacitors (For input smoothing circuit)

Frequency (Hz)	50	60	120	300	1k	10k	50k~
Frequency coefficient (Kf)	16~100V	0.88	0.90	1.00	1.07	1.15	1.15
	160~250V	0.81	0.85	1.00	1.17	1.32	1.45
	315~450V	0.77	0.82	1.00	1.16	1.30	1.41

• Lead type capacitors (For output smoothing circuit)

Rated voltage(V)	Frequency Cap.(μF)	50	120	300	1k	10k~
	~56	0.20	0.30	0.50	0.80	1.00
6.3~100V	68~330	0.55	0.65	0.75	0.85	1.00
	390~1000	0.70	0.75	0.80	0.90	1.00
	1200~15000	0.80	0.85	0.90	0.95	1.00

3) Temperature Coefficient of Allowable Ripple Current

The applicable ripple current value below the maximum operating temperature must be limited by specified ripple temperature rise at the center of element per ambient temperature.(Table 2-6.)

Table 2-6 Limit of element core temperature rise (Over 315 Voltage with Snap-in terminal type capacitors)

Ambient Temperature (°C)	40	55	65	85	105
Δtc (°C)	30	30	25	15	5

4) The method which seeks for effective current value from Ripple current wave form

In case that a ripple, which ripple current of high

frequency switching is superimposed upon commercial frequency ripple, is applied, such as in switching power supplies, inverter type supplies and active filter circuits, there is a method to obtain the effective value from the waveform pattern in Table 2-7 by finding the similar waveform observed in actuality.

Table 2-7 Current Wave and Calculation Expression for Effective Value

	Wave form	Formula of effective value
①		$I_{rms} = \frac{I_p}{\sqrt{2}}$
②		$I_{rms} = I_p \sqrt{\frac{T_1}{2T}}$
③		$I_{rms} = I_p \sqrt{\frac{T_1}{T}}$
④		$I_{rms} = I_p \sqrt{\frac{T_1}{3T}}$

Effective ripple value is calculated from the wave form of ripple, which ripple current of high frequency switching (I_H) is superposed upon ripple current of commercial frequency (I_L) (as in Figure 2-17), by dividing it into each frequency component.

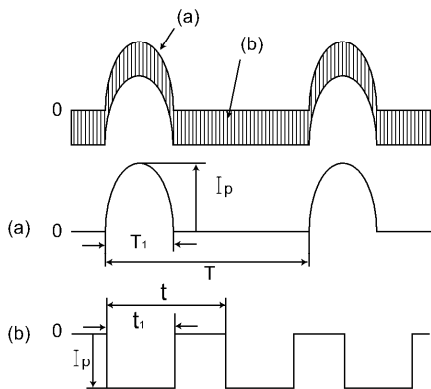

Fig. 2-17

Setting Model ② as the ripple current for a low frequency component (I_L):

$$I_L = I_p \times \sqrt{\frac{T_1}{2T}} \dots\dots (2-15)$$

Setting Model ③ as the ripple current for a high frequency component (I_H):

$$I_H = I_p \times \sqrt{\frac{t_1}{t}} \dots\dots (2-16)$$

The equivalent series resistance of aluminum electrolytic capacitors has frequency characteristics; so if the frequency is different from the standard, it is converted to meet the standard frequency. If the frequency coefficient

for low frequency components is labeled "K_{FL}" and the frequency coefficient for high frequency components is labeled "K_{FH}," the synthetic ripple "I_n" converted to the standard frequency is:

$$I_n = \sqrt{\left(\frac{I_L}{K_{FL}}\right)^2 + \left(\frac{I_H}{K_{FH}}\right)^2} \dots\dots (2-17)$$

5) Estimating Temperature Rise due to Ripple Current

Power loss is proportional to the second power of ripple current. If the temperature rises at the middle of the element, when the permissible ripple current "I_o" (A), is labeled "Δt_o," the temperature rise when ripple current "I_n" (A) is applied would be as follows:

$$\Delta t_n = \left(\frac{I_n}{I_o}\right)^2 \times \Delta t_o \dots\dots (2-18)$$

The temperature rise "Δt_o" for a 105°C snap-in terminal type capacitor is approximately 5°C. However, since the equivalent series resistance "R_e" of aluminum electrolytic capacitors differs according to the temperature and because the ripple current wave - form has many complex frequency components in actuality, we recommend that the temperature rise is actually measured with thermocouples.

2-9-6 Estimated Life

The estimated life of an aluminum electrolytic capacitor is represented multiplying the specified life time on Nichicon catalog F_r, F₁, and F_u as explained in 2-9-1. Shown below are the formulase for obtaining the expected life for the large can type aluminum electrolytic capacitors and the miniature aluminum electrolytic capacitors. For further details, consult Nichicon.

(Large can type)

Formula 2-19 is for obtaining the estimated life of a large can type electrolytic capacitor.

For the formula for the screw terminal capacitors, please consult Nichicon.

$$L_n = L_o \times 2^{\frac{T_o - T_n}{10}} \times 2^{1 - \frac{\Delta t_n - \Delta t_o}{K}} \times \left(\frac{I_n}{I_m}\right)^2 \dots\dots (2-19)$$

L_n: Estimated life (h) at ambient temperature of T_n (°C) with a ripple current I_n (Arms) applied.

L_o: Specified life time (h) at maximum operating temperature T_o (°C) with the specified maximum allowable ripple current I_m (Arms) at T_o (°C) applied

T_o: Maximum operating temperature of the capacitor (°C)

T_n: Ambient temperature of the capacitor (°C)

Δt_o: The internal temperature rise (°C) of the capacitor at ambient temperature T_o (°C) with the maximum allowable ripple current I_m (Arms) at T_o applied

Δt_n: The internal temperature rise (°C) of the capacitor at ambient temperature T_n (°C) with the actually applied ripple current I_n (Arms)

K: Acceleration coefficient of temperature rise due to

ripple [refer to the chart below ; applicable coefficient is for the range below the maximum operating temperature T_o ($^{\circ}\text{C}$)

- The formula is applicable for the range of ambient temperature T_n of 40°C and the maximum operating temperature T_o . Please note that fifteen years is generally considered to be the maximum for the estimated life obtained by the above formula.

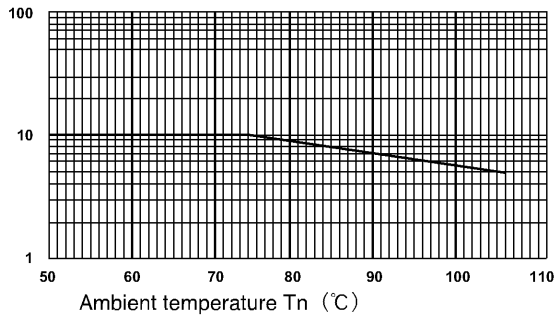

Fig 2-18 Acceleration coefficient of temperature rise due to ripple; K

(Miniature type)

There are two formulase for obtaining the estimated life of a miniature aluminum electrolytic capacitor, depending on the life specification of series on Nichicon catalog as shown in formulase 2-20 and 2-21.

(1) Capacitors life time is specified. with rated DC vortage applied only

$$L_n = L \times 2^{\frac{T_o - T_n}{10}} \times \frac{1}{B_n} \dots\dots\dots (2-20)$$

Where $B_n = 2^{\alpha} \times \left(\frac{I_n}{I_m}\right)^2 \times 2^{-\left(\frac{T_n - T_n}{30}\right)}$

(2) Capacitors life time is specified with D.C. bias voltage plus rated ripple current.

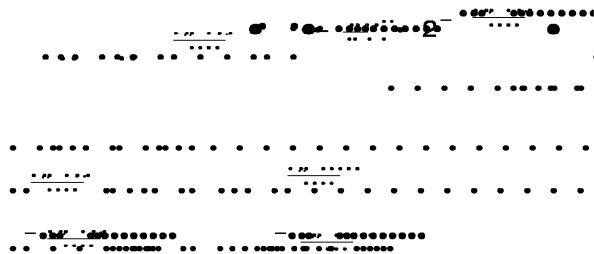

L_n : Estimated life time (h) at ambient temperature of T_n ($^{\circ}\text{C}$) with a ripple current I_n (Arms) applied.

L : Specified life time (h) at maximum operating temperature T ($^{\circ}\text{C}$) with the rated DC voltage applied.

L_o : Specified life time (h) at maximum operating temperature T ($^{\circ}\text{C}$) with the specified maximum allowable ripple current I_m (Arms) at T ($^{\circ}\text{C}$) applied.

T_o : Maximum operating temperature of the capacitor ($^{\circ}\text{C}$)

T_n : Ambient temperature of the capacitor ($^{\circ}\text{C}$)

I_m : Rated ripple current (Arms) at maximum operating temperature T ($^{\circ}\text{C}$)

I_m need to be valued in the same frequency as that of the ripple current being used by multiplying specified ripple-frequency coefficient in Nichicon catalog.

I_n : Ripple current (Arms) actually applied at ambient temperature T_n ($^{\circ}\text{C}$)

B_n : Acceleration coefficient when ripple I_n (Arms) is applied at ambient temperature T_n ($^{\circ}\text{C}$)

α : Life constant

Contact us for details regarding the life constant.

The formula is applicable for the range of ambient temperature T_n of 40°C and the maximum operating temperature T_o . Please note that calculated life time is for reference only and not guaranteed. Typically, fifteen years is generally considered to be the maximum for the estimated life obtained by the above formula.

2-10 Effects of halogen

2-10-1 Foreword

When a halide substance seeps into the aluminum electrolytic capacitor:

The halide dissolves and frees halogen ions.



Also, the following reaction (Electricity cauterization reaction) can occur

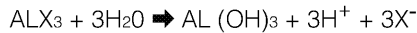

When this reaction is repeated, the leakage current increases and the safety vent will be activated and may lead to open vent. Because of this, halogen type cleaning agents or adhesive material and coating material is not recommended for usage. The following explains the recommended conditions for using cleaning agents, adhesive material and coating material. 2-10-3 explains the recommended condition for cleaning, when a halogen type cleaning agent will be used due to cleaning capabilities.

2-10-2 Recommended Cleaning Condition

Applicable : Any type, any ratings.

Cleaning Agents : Based Alcohole solvent cleaning agent
Isopropyl Alcohol

Based water solvent cleaning agent

- Premium alcohole solvent type

Pine Alpha ST-100S

Techno Care FRW 14~17

Sanelek B-12

- Surfactant type

Clean Through 750H, 750L, 710M

- Alkaline saponification agent

Aqua Cleaner 210SEP

Cleaning Conditions : Total cleaning time shall be no greater than 5 minutes by immersion, ultrasonic or other method.

(Temperature of the cleaning agent shall be 60°C maximum.)

After the board cleaning has been completed, the capacitors should be dried using hot air for a minimum of 10 minutes.

If the cleaning solution is infiltrated between the case and the sleeve, the sleeve might soften and swell when hot air temperature is too high. Therefore, hot air temperature should not exceed softening temperature(80°C) of the sleeve.

Hot air temperature should be below the maximum operating temperature of the capacitor.

Insufficient dries after water rinse may cause appearance problems, such as sleeve shrinking, bottom-plate bulging. In addition, a monitoring of the contamination of cleaning agents (electric conductivity, pH, specific gravity, water content, etc.) must be implemented.

After the cleaning, do not keep the capacitors in an atmosphere containing the cleaning agent or in an air tight container.

Depending on the cleaning method, the marking on a capacitor may be erased or blurred.

Consult Nichicon before using a cleaning method or a cleaning agent other than those recommended.

The use of hydro-chlorofluorocarbon (HCFC) is expected to be banned in the future and Nichicon does not recommend the use of HCFC as a cleaning agent considering its impact on the environment. When it is absolutely necessary to use HCFC, cleaning is possible under the following conditions:

Applicable : Anti-solvent capacitors (listed in the catalogue)

Cleaning Agents : AK-225AES

Cleaning Conditions : Within 5 minutes, total cleaning time by immersion, vapor spray, or ultrasonic and such. For SMD and ultra-miniature type, 2 minutes maximum of total cleaning time. (Temperature of agent: 40°C or below)

Notes : Monitoring of the contamination of cleaning agents (electric conductivity, pH, specific gravity, water content, etc.) must be implemented.

After the cleaning, do not keep the capacitors in an atmosphere containing the cleaning agent or in an air tight container.

Consult Nichicon before using a cleaning method or cleaning agent other than those recommended.

2-10-3 Fixing Material and Coating Material

1) Do not use any affixing or coating materials, which contain halide substance.

2) Remove flux and any contamination, which remains in the gap between the end seal and PC board.

3) Please dry the cleaning agent on the PC board before using affixing or coating materials.

4) Please do not apply any material all around the end seal when using affixing or coating materials.

There are variations of cleaning agents, fixing and coating materials, so please contact those manufacture or our sales office to make sure that the material would not cause any problems.

2-10-4 Others

Wooden package material may be subjected to fumigation by a halogen (e.g. methyl bromide) before they are exported in order to protect them against pests. If devices with aluminum electrolytic capacitors or capacitors themselves are directly fumigated or packed with the pallet that is fumigated, the capacitors may internally corrode due to the halogen contents of fumigation agents.

2-11 CR Timing Circuit

2-11-1 Foreword

The following will explain precautions to be taken when considering usage of the aluminum electrolytic capacitor in a timing circuit and calculating out the timing for maintenance.

2-11-2 Recharge Circuit

The lead voltage of the capacitor, when applied voltage (V) is applied to capacitor (C) with series resistor (Ω) as in figure 2-19, must be taken into consideration.

Figure 2-20 shows the rise of terminal voltage during charging of the capacitor. The time "tn" needed to reach a specified voltage "Vn" may be expressed by formula 2-23.

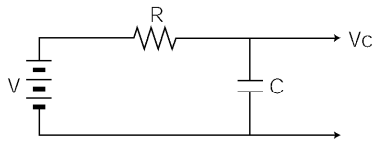

Fig. 2 - 19

$$V_c = V(1 - e^{-\frac{t}{CR}}) \dots\dots\dots (2-22)$$

$$t_n = CR \ln \left(\frac{V}{V - V_n} \right) \dots\dots\dots (2-23)$$

- R : Series resistor (Ω)
- C : Capacitance (μF)
- V : Applied voltage (V)

2-11-3 Discharge Circuit

Figure 2-20 shows the situation where capacitor C is discharged with resistance Rd by laying down switch SW toward 2, after it has been charged with applied voltage V by laying down switch SW toward 1. The relationship between the terminal voltage Vc (V) and discharge time (t) may be expressed by formula 2-22. The time "tn" needed for the terminal voltage "Vc" (V) of a capacitor to reach voltage "Vn" may be expressed by formula 2-23.

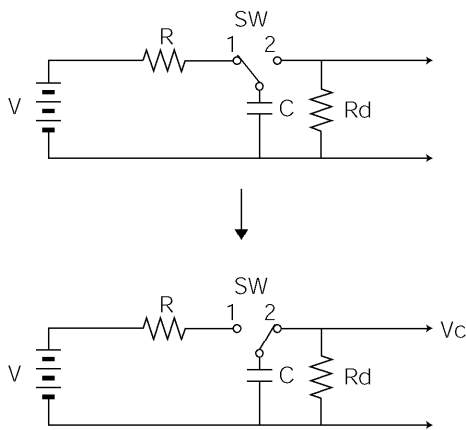

Fig. 2 - 20

$$V_c = V \times e^{-\frac{t}{CR_d}} \dots\dots\dots (2-24)$$

$$t_n = CR_d \ln \left(\frac{V}{V_n} \right) \dots\dots\dots (2-25)$$

- Rd : Discharge resistor (Ω)
- C : Capacitance (μF)
- V : Applied voltage (V)

2-11-4 Leakage Current Resistance of Capacitors

When DC voltage is applied, leakage current flows through a capacitor. The leakage current of aluminum electrolytic capacitors is larger than other types of capacitors; furthermore, the leakage current changes according to the temperature, applied voltage and application time. If considering an equivalent circuit, the leakage current can be thought as the current flows through a resistance, which is connected in parallel to a capacitor. Leakage current becomes the power loss when capacitors are charged and self-discharge source when capacitors are discharged; therefore, it increases with error for the theoretical formulas shown in 2-11-2 and 2-11-3.

The time constant in charge becomes larger than theoretical value and time constant in discharge becomes smaller than theoretical value.

It is important to confirm that the capacitor meets the necessary requirements within the operating temperature range of the equipment, when using an aluminum electrolytic capacitor in a timing circuit.

2-12 Setting Up Capacitors

2-12-1 Foreword

The aluminum electrolytic capacitor is the most commonly used type of capacitor in a smoothing circuit. The reason for this is because the aluminum electrolytic capacitor has a higher capacitance/unit volume and also lower price/unit capacitance compared to other types of capacitors.

In the electrical component market, use of surface mount (SMD) types progresses due to demands for miniature, high efficiency, high frequency, high reliability and thin type electronic equipment. Furthermore, the PL Law (Product Liability) has been enforced, therefore, safety is regarded as important more than before. For such reasons, aluminum electrolytic capacitors that are used in power supplies are required to have the following features: miniature, light in weight, thin, extended life and high reliability, chip type, and safer. The following discusses factors that will help in proficiently using aluminum electrolytic capacitors.

2-12-2 Characteristics of the Aluminum Electrolytic Capacitor Series

(1) Capacitor for input smoothing circuit of a power supply

Capacitors for input smoothing circuit of a power supply are located after diodes. They work to smooth the electrical current that rectified in the diode and are required to have characteristics, such as high ripple, high reliability and safety. Table 2-8 shows the series matrix for Can Type (snap-in terminal type) capacitors.

Table. 2 - 8 Series Matrix for Can type (Snap-in Terminal type) Capacitors

Feature Configuration	85°C Type		105°C Type				
	Standard type	Miniature type	Standard type	Miniature type	Long life (7000h)	Permissible abnormal voltage	Withstanding overvoltage
Standard type	LS	LN, LG	GU	GN, GG	GY	AK <small>AD, AS, smaller sized</small>	AD
Low profile	-	-	GJ, GJ ₍₁₅₎	-	-	-	-
Horizontal mounting type	DM	-	DQ	-	-	-	-

The standard for 105°C capacitors is GU series; GN,GG is recommended if a miniature type is required; GJ is recommended if a low profile-type is required; finally, DQ is recommended if a horizontal mounting type is necessary to decrease the height in the application even further. If a higher reliable capacitor is required, GY series with guaranteed life of 7000 hours is recommended. As Figure 2-20 shows, for a power supply unit of commercial 100V /200V change type, a capacitor rated voltage of 250V is normally used. However, if mistakenly connect to 200V line when the switch is ON, a standard 250V part would become under over voltage conditions and will open vent in short time period. A capacitor that would not open vent under such conditions for a set amount of time is AD series. AK and AQ series is designed with specifications and construction that prevents the capacitor

from short circuit conditions by allowing open-vent (which does not endanger the capacitor to catch fire). These series are recommended for usage in electrical equipment that are in constant operating 24 hours a day, such as facsimile machines and copy machines and other telecommunication equipments.

(2)Capacitors for Usage in Output Smoothing Circuit of a Power Supply

Capacitors for usage in electrical output smoothing circuits are important to provide steady output voltage. With the switching frequency rising, capacitors within a high frequency range and with low impedance, equivalent series resistance are required. Furthermore, surface mount components (SMD) are being used in miniature switching power supplies and DC-DC converters. Table 2-9 shows the series matrix for radial lead type capacitors, and Table 2-10 is the series matrix for surface mount devices.

Table. 2 - 9 Series Matrix for Lead type Capacitors

Feature Configuration	Standard	105°C Type	125°C Type	Bi-polarized	Low impedance	Long life (105°C/5000h)
5mmL	MA	MT	—	MP	MF	MV
7mmL	SA,SR	ST		SP	SF	SV
11mmL or more	VR,RS	VZ,RZ	BT	VP	PJ,PM	PV

Table. 2 - 1 0 Series Matrix for Chip type Capacitors

Feature Configuration	Standard	105°C Type	125°C type	Bi-polarized
3.0mmL	ZD	-	-	-
3.95mmL	ZR	ZG	-	ZE
4.5mmL	ZS	ZT	-	ZP
5.5mmL	WX	WT <small>WF (Low impedance)</small>	-	WP
6.2mmL or more	UR	UT <small>UL (Long life) UX (High C / V)</small>	UB	UP
Higher capacitance	UG	UJ	UH	UN

The standard series for usage in output smoothing circuit of a power supply is PJ, PS, SF (7mmL),and / or MF (5mmL) recommended if a miniature type is required, PM is recommended for low impedance requirements, PW is recommended if a low impedance, miniature type is required.

As for surface mount capacitors, WT is the standard series; for a capacitor with low height, ZT,ZG is recommended; WF is recommended if a low impedance series is needed; finally, UX and UJ is designed in a higher voltage and higher capacitance range.

(3) Capacitors for Usage in Control Circuits

In some cases, failure of capacitors for usage in control circuits may occur, due to the ambient temperature rising in electrical equipment that are led by miniature, multi-functioning, and high density assembly. This rise in the ambient temperature may occur if the capacitor is mounted near another component that generates heat. Nichicon has designed several capacitors for usage in control circuits: VZ (miniature type) has a maximum operating temperature of 105°C, and there are others, such as PV (long life), SV (7mmL) and MV (5mmL).

Please see our catalogue for more details on our series.

2-12-3 High density mounting and extension of product life

The ambient temperature of the capacitor is rising, due to electrical equipment becoming more miniaturized, multi-functioning, and its high density mounting conditions. In addition, there is much equipment that is continually operated, so the demands for higher reliability and longer life have become greater. The life of aluminum electrolytic capacitors is shortened as the ambient temperature rises. Please consider the following in order to prolong the life of the aluminum electrolytic capacitor.

- ① Please do not design a circuit board so that heat generating components are placed near an aluminum electrolytic capacitor on the or reverse side of the PC board.
- ② Please release as much heat as possible inside the electrical equipment, using a heat radiator fan or other device.
- ③ Please have a hole somewhere in the equipment, so that the temperature within the electrical equipment will decrease, and open air coming through the hole will cool off the capacitor.
- ④ Especially in electrical equipment that uses a double-sided circuit board requires care. If the capacitor is placed near a power module or heat generating component, there is a case that capacitor is exposed to the high temperature transmitted through circuit pattern. In particular, please pay attention when capacitor is used for a high power supply.
- ⑤ The internal temperature of an electrical equipment is higher toward the top. Please set the capacitor a low position within the electrical device. Please consider this especially if the device is used standing upward.

2-12-4 In-rush current and Discharge Resistance

In the capacitor input type power supply, an in-rush current flows through the capacitor at the time of power-on. The in-rush current differs according to the timing of power-on, but it can be 10 times the constant current. If the in-rush current is repeated only several times a day, there should be no problem. However, if electrical input and turn-off is repeated frequently or if the electromagnetic noise that occurs at input causes any hindrance to the equipment, we recommend that an inductance or active filter is added to the circuit on the input side. If the circuit be designed so that the capacitor is automatically discharged when the electricity is turned off, we recommend that the capacitor is discharged with a discharge resistance of 1kΩ or more.

2-12-5 Surface Mount Type Capacitors

As a surface mount replacement for radial leaded parts, chip aluminum electrolytic capacitors are required to have good stability, solderability and resistance to heat, in order to be reflow soldered onto PC boards. In order to meet such requirements, we have processed the lead wiring into a flat lead and have attached a plastic platform that resists high heat; such capacitors are the mainstream in the vertical mount chip-type capacitors.

We are offering a wide range of vertical mount chip-type capacitors in case sizes φ 3, 4, 5, 6.3, 8 and 10mm, in rated voltages of 4V~50V with capacitance of 0.1~1500μF; we are also offering these capacitors with case sizes φ12.5, 16, 18, 20mm, in voltage of 6.3V~450V, with a capacitance range of 3.3μF~10000μF. Figure 2-23 shows the outward appearance of chip aluminum electrolytic capacitors. For more details, please see our catalog.

(Example)

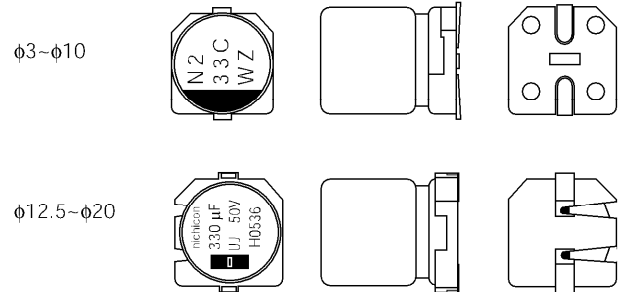

Fig. 2-23 Outward appearance of chip aluminum electrolytic capacitors