

Fig. 2A

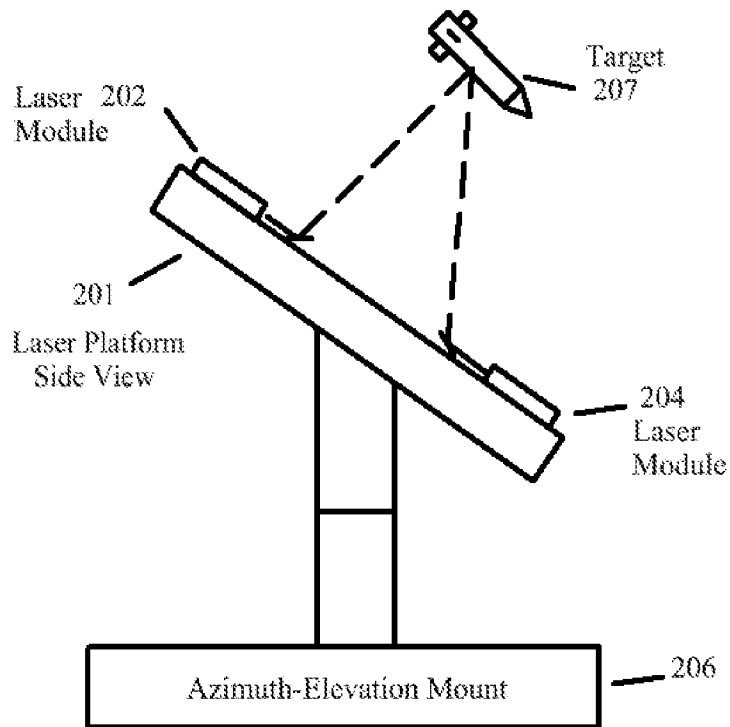

Fig. 2B