

Fig. 5A

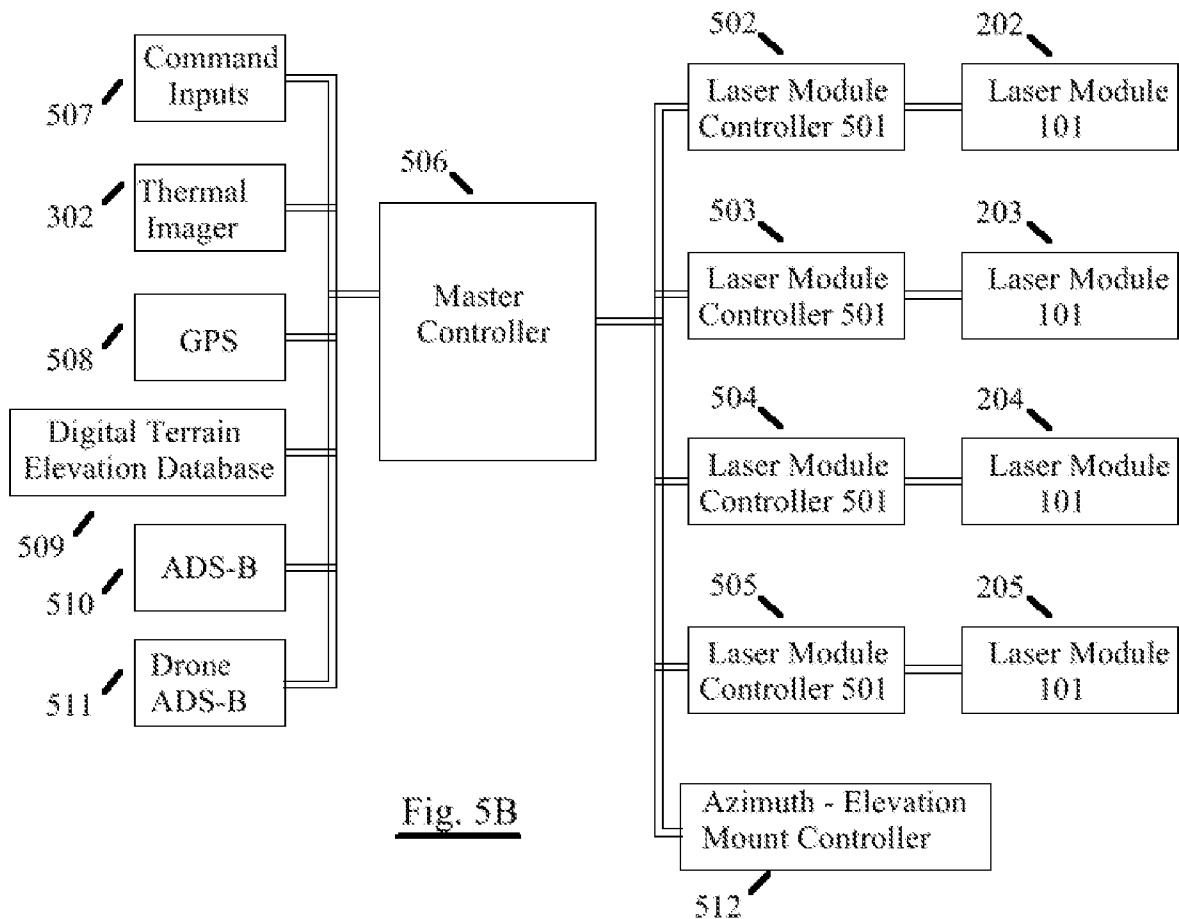

Fig. 5B